



Campagnolo



Campagnolo

Sole Technical Advisor to:

- August, 1974 — World Professional and Amateur Cycling Championships — *Canada*
- June, 1975 — European Junior Cycling Championships — *Switzerland*
- July, 1975 — United States National Cycling Championships — *U. S. A.*
- August, 1975 — World Professional and Amateur Cycling Championships — *Belgium*
- October, 1975 — Pan American Games — *Mexico*
- July, 1976 — Olympic Games — *Canada*
- August, 1977 — World Professional and Amateur Cycling Championships — *Venezuela*

WARRANTY

Campagnolo bicycle components are unconditionally guaranteed for life against defects in materials or workmanship. Campagnolo components are not, however, guaranteed against wear resulting from use or wear resulting from improper maintenance.



CAMPAGNOLO®

BREV. INTER. CAMPAGNOLO®

Copyright © 1975

All copyrights reserved and reproduction prohibited.

Any person infringing Campagnolo patents, trade marks, and registered designs will be prosecuted.

TABLE OF CONTENTS

| | |
|--|-------|
| Super Record Road Group | 2-3 |
| Nuovo Record Road Group | 4-5 |
| Super Record Track Group | 6-7 |
| Record Track Group | 8-9 |
| Gran Sport Road Group | 10-11 |
| Derailleurs and Parts | 12-18 |
| Controls and Parts | 19-21 |
| Hubs and Parts | 22-26 |
| Cranksets and Parts | 27-30 |
| Bottom Bracket Sets and Parts | 31-33 |
| Headsets and Parts | 34 |
| Pedals and Parts | 35-36 |
| Brakes and Parts | 37-38 |
| Seatpins and Parts | 39-40 |
| Cables and Clips | 41 |
| Binder Bolts | 42 |
| Fork Ends | 43 |
| Pump Ends, Track Sprockets, and Grease | 44 |
| Special Campagnolo Tools | 45-49 |
| Bicycle Assembly Stand | 50 |
| Chain Line Diagrams | 51-53 |
| Gear Table for 27" Wheels | 54 |

4000/F CAMPAGNOLO SUPER RECORD ROAD GROUP

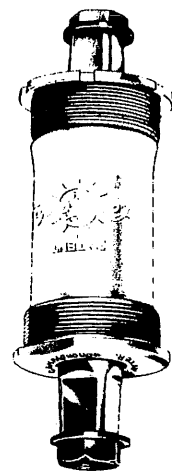
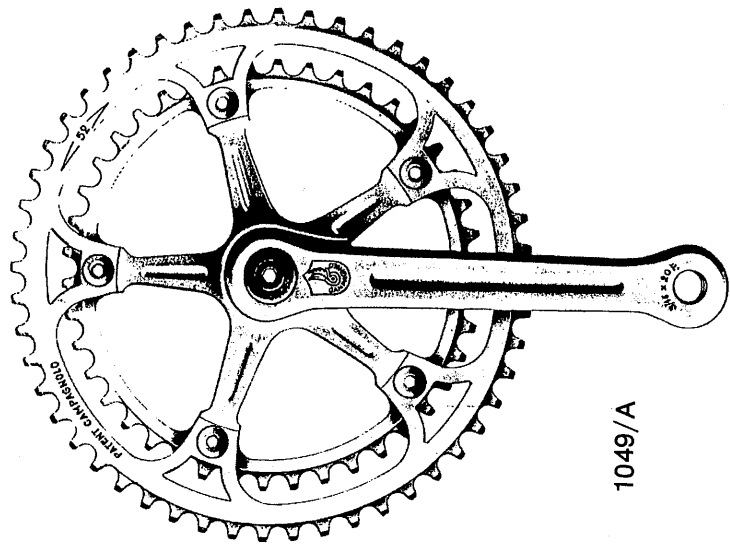
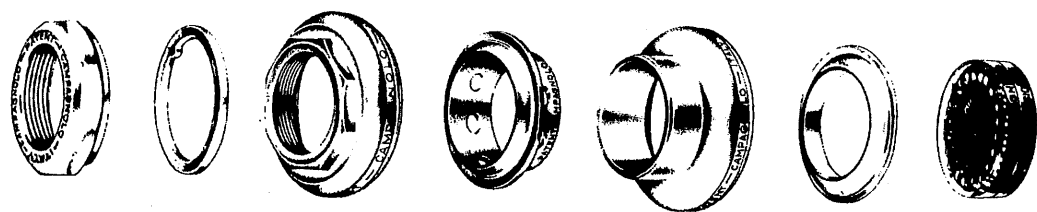
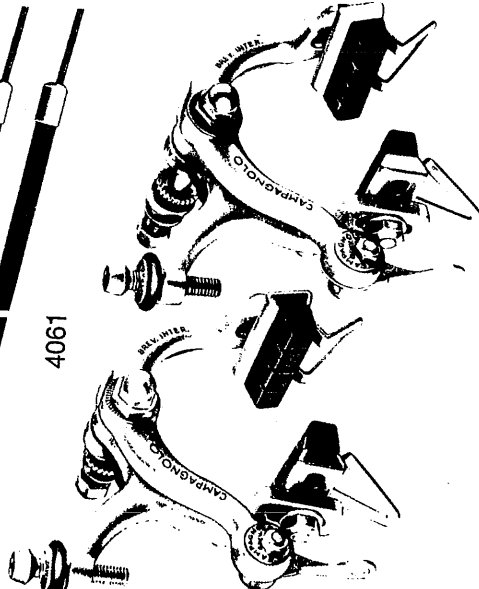
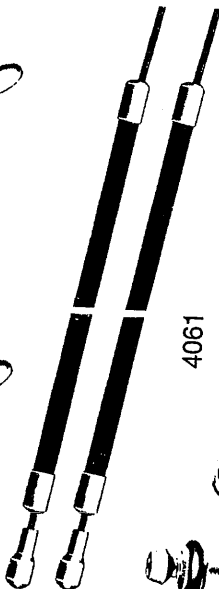
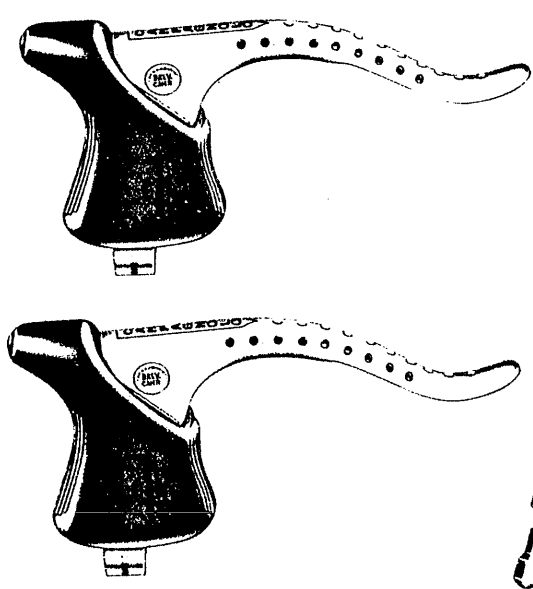

- 606 Rear derailleur cable (118 cm.)
- 608 Front derailleur cable (72 cm.) (New cable has been lengthened 2 cm.)
- 622 Rear derailleur stainless steel cable casing (21 cm.)
- 626/A Dual derailleur cable guide
- 636 Rear derailleur cable stop
- 648 Peg-Type pump holder
- 649 Brake cable clip (pkg. of 3)
- 1010/A Road fork ends w/o eyelets - set of 4 (SR)
- 1014 Record dual derailleur controls
- 1030/2 Adapter for Italian Silco Impero Pump w/squared boss
- 1049/A Super Record crankset w/o BB (Specs: Crank length—165 to 180 mm; Teeth—42 to 57)
- 1052/1 Front derailleur (R, RL, SR)

SUPER RECORD ROAD GROUP

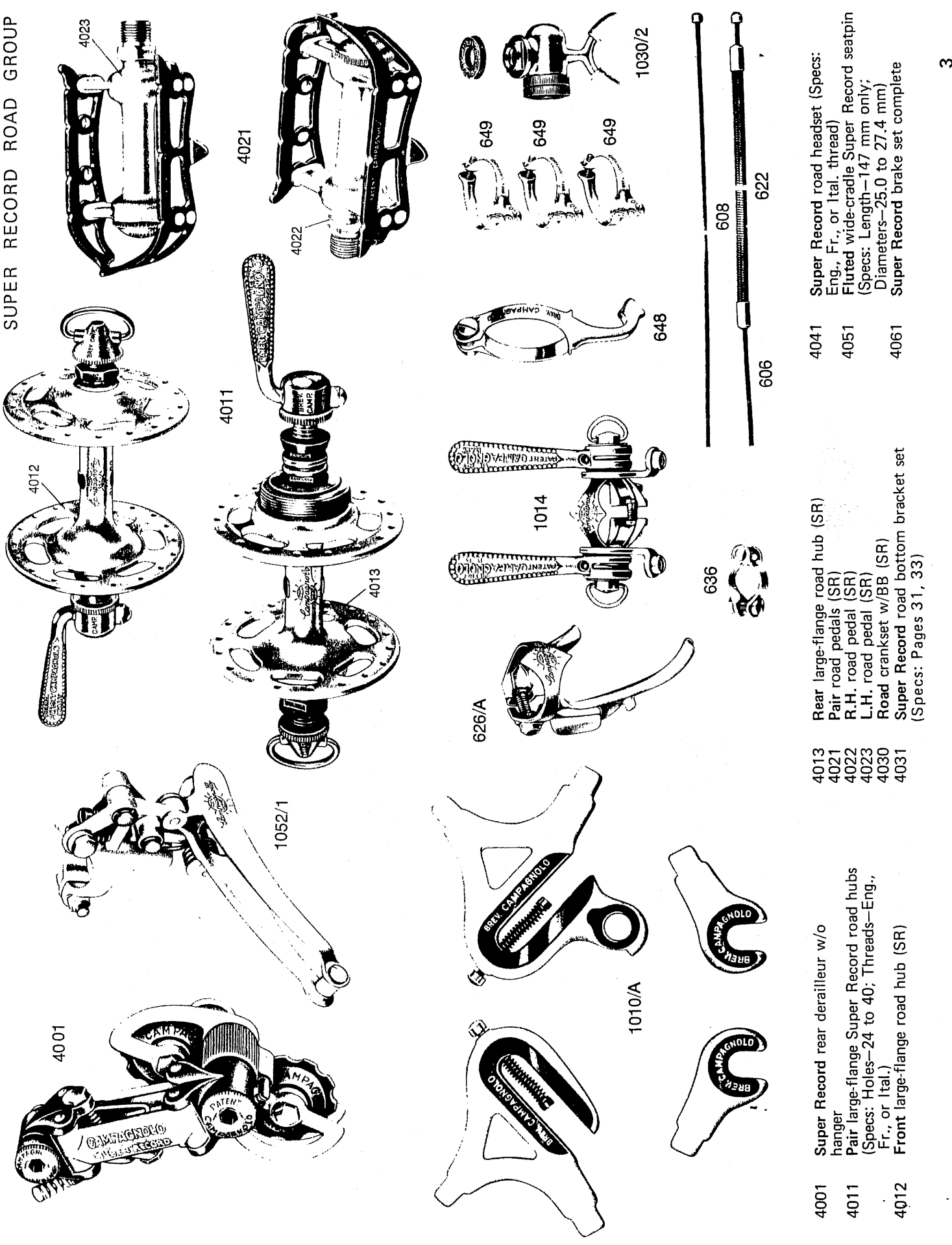

- 4001 Super Record rear derailleur w/o hanger
- 4011 Pair large-flange Super Record road hubs (Specs: Holes—24 to 40; Threads—Eng., Fr., or Ital.)
- 4012 Front large-flange road hub (SR)
- 4013 Road crankset w/BB (SR) (Specs: Pages 31, 33)
- 4021 Super Record road headset (Specs: Eng., Fr., or Ital. thread)
- 4022 Fluted wide-cradle Super Record seatpin (Specs: Length—147 mm only; Diameters—25.0 to 27.4 mm)
- 4023 Super Record brake set complete
- 626/A Brake lever
- 648 Brake lever
- 649 Brake cable
- 606 Seatpost
- 608 Seatpost
- 636 Seatpost cap
- 636/2 Seatpost cap
- 1010/A Campagnolo brake lever
- 1014 Campagnolo brake lever
- 1052/1 Campagnolo front fender

1032/F CAMPAGNOLO NUOVO RECORD ROAD GROUP (INCLUDES BRAKES 2040, PAGE 37)
 1032 CAMPAGNOLO NUOVO RECORD ROAD GROUP (AS SHOWN - DOES NOT INCLUDE BRAKES 2040)

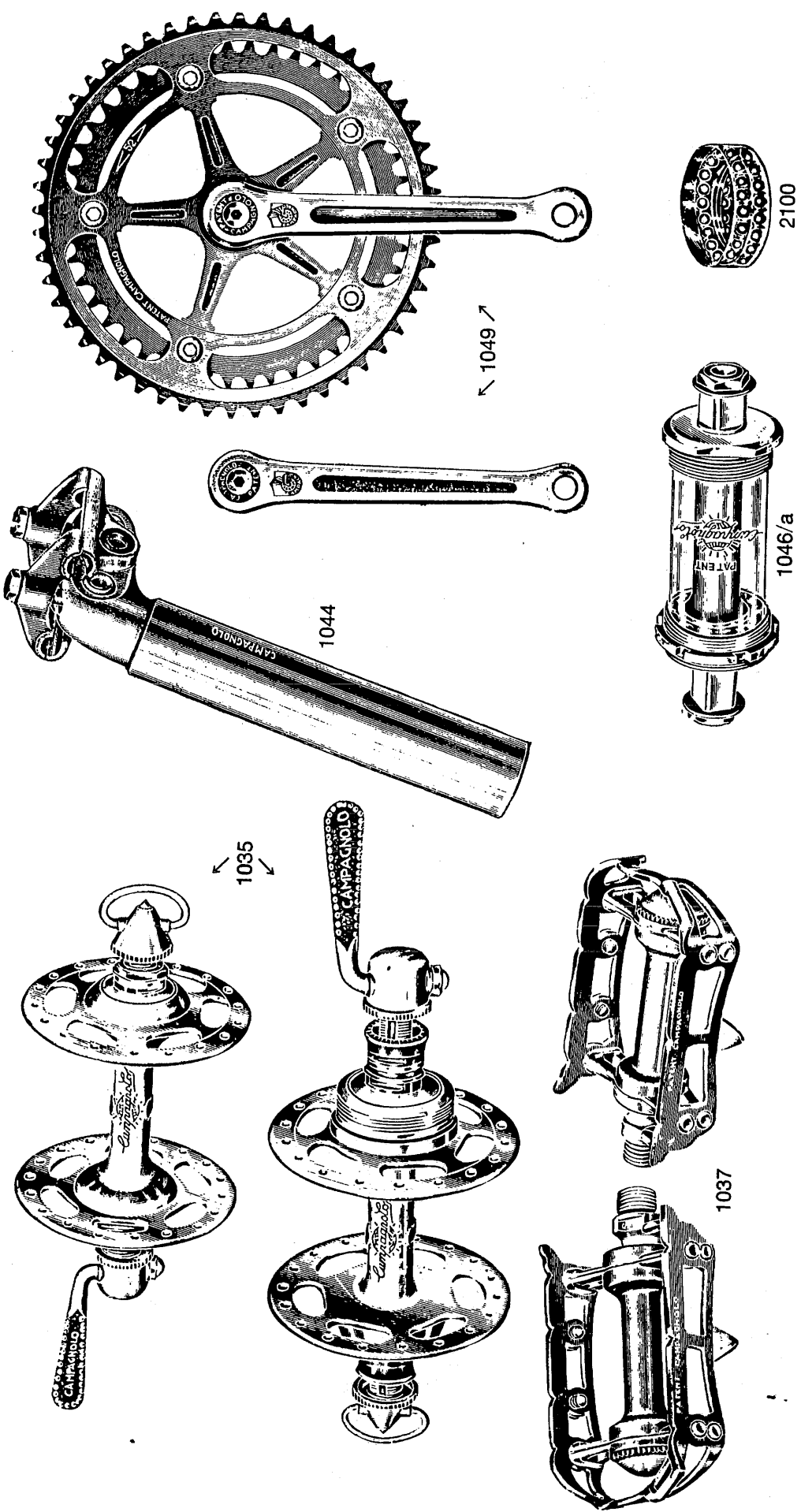

- 606 Down tube gear cable (118 cm)
- 608 Down tube front changer cable (72 cm)
- 622 Rear stainless steel outer cable (21 cm)
- 626/a Twin gear cables clip
- 632 Seat tube pump clip
- 636 Rear derailleur cable stop

- 649 Brake cable clips
- 1010 Record fork ends set
- 1014 Twin down tube control levers
- 1020/a Nuovo Record gear (without hanger)
- 1030/2 Special pump adaptor (thread $\varnothing 9 \times 1,25$ - Any of the pump adaptors shown on page 44 can be supplied instead)

NUOVO RECORD ROAD GROUP

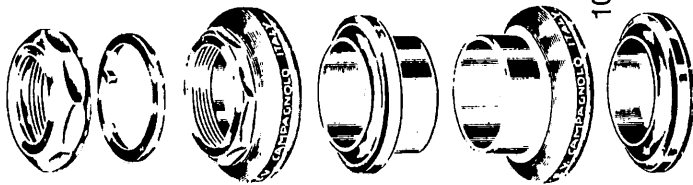

1039



2101

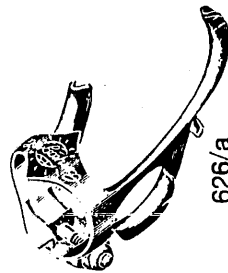

626/a

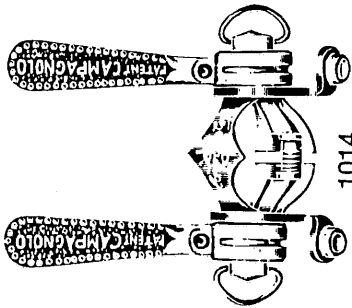

1014

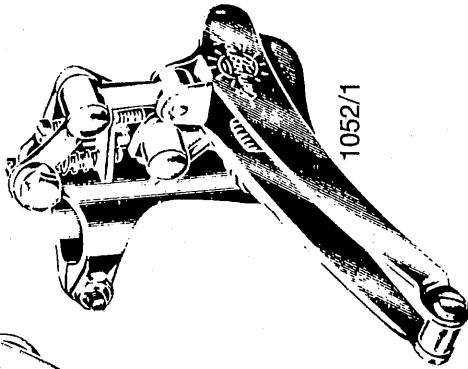

1052/1

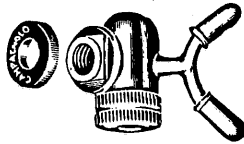

1030/2



649



649



649

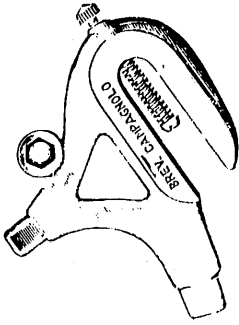

1010

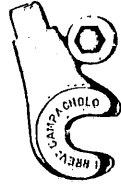

608



606

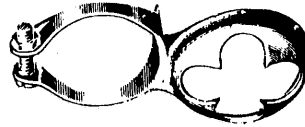

632



636



- 1046/a Nuovo Record bottom bracket set (see pages 32, 33 for specs)
- 1048 Road crankset w/BB (NR)
- 1049 Road chainwheel set (please specify number of chainring teeth and crank length—see page 27)
- 1052/1 Record front changer
- 2100 Special ballraces for bottom bracket set
- 2101 Special ballraces for head set

- 1035 Pair of Record large flange quick release hubs (Specs: Holes—24 to 40; Thread—Eng., Fr. or Ital.)
- 1037 Pair of Record road pedals
- 1039 Record road head set (Specify Eng., Fr. or Ital. Thread)
- 1044 Seat pin (please specify diameter and length as shown on pages 39 and 40. If requested, seat pin 1045 for narrow cradle saddles can be supplied.)

4100 CAMPAGNOLO SUPER RECORD TRACK GROUP

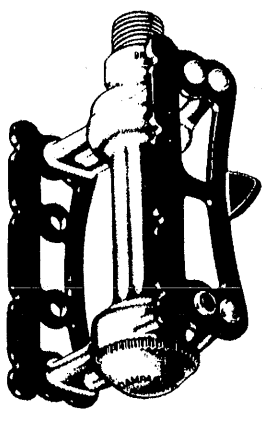
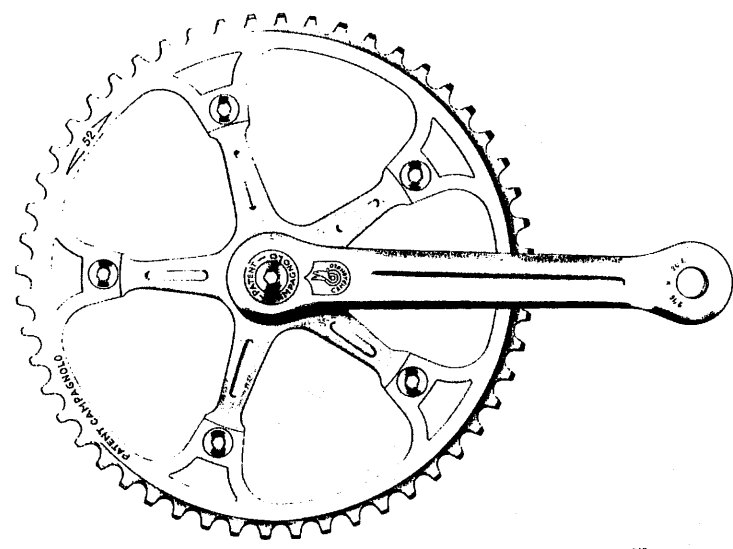

4121

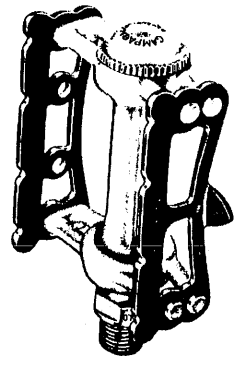

4131

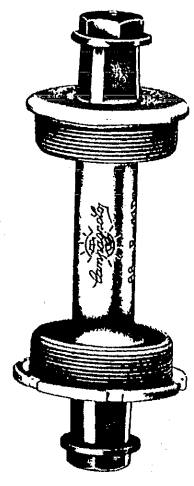

4151

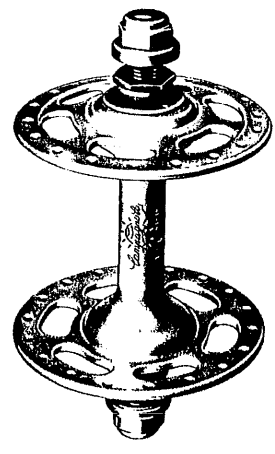
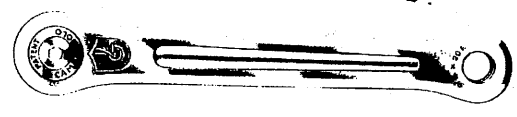

4101

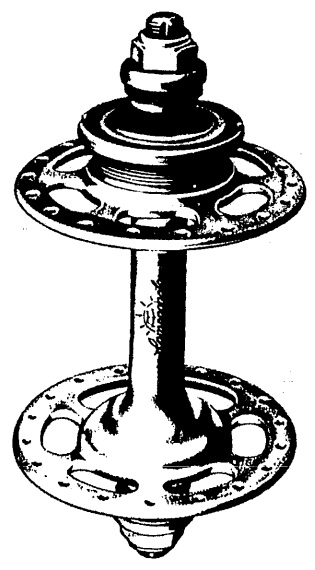

- 4102 Front large-flange track hub (SR)
- 4103 Rear Large-flange track hub (SR)
- 4121 Pair track pedals (SR)
- 4122 R.H. track pedal (SR)
- 4123 L.H. track pedal (SR)
- 4130 Track crankset w/BB (SR)

- 1053 Track fork ends (set of 4)
- 4051 Fluted wide-cradle seat pin (SR)—147 mm only; diameters 25.0 to 27.4 mm
- 4101 Pair large-flange Super Record track hubs (Specs: Holes—24 to 40; Threads—Eng., Fr., or Ital.)

SUPER RECORD TRACK GROUP

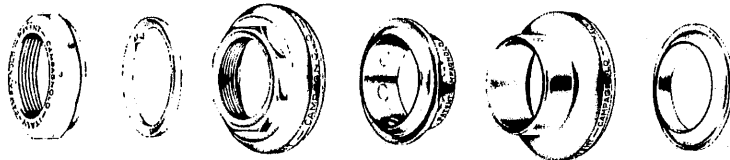

4141

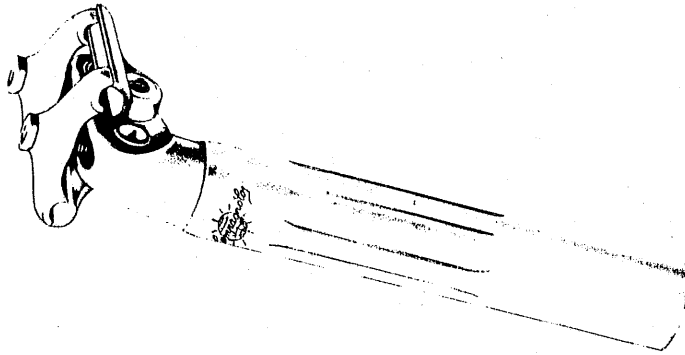

4051

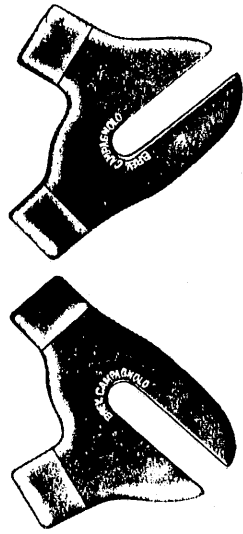

1053



- 4131 Track bottom bracket set (SR)
(See specs pages 31, 33)
- 4141 Super Record track headset (Specs - Eng.,
Fr., or Ital. thread)
- 4151 Super Record track crankset w/o bottom
bracket - to fit 1/2" x 1/8" (3 mm) chain
(Specs: Crank length—165 to 180 mm;
Teeth size—44 to 70)

1033 CAMPAGNOLO RECORD TRACK GROUP

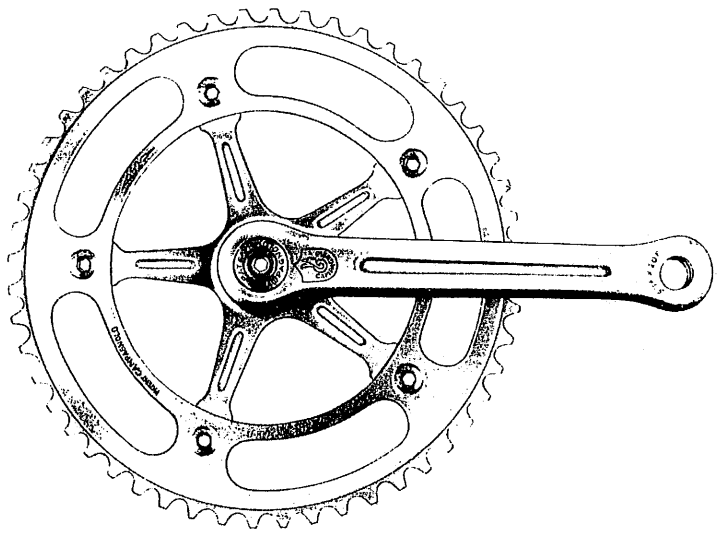

1051

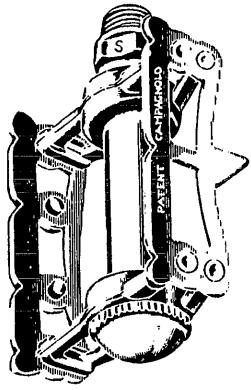
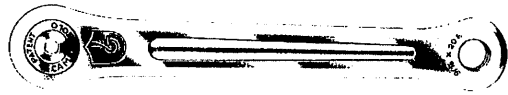

1038

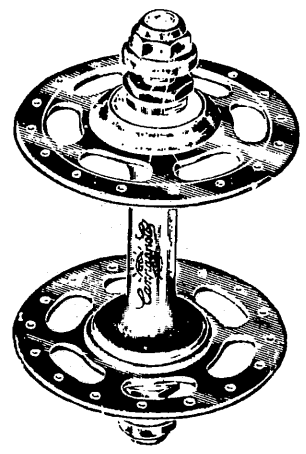
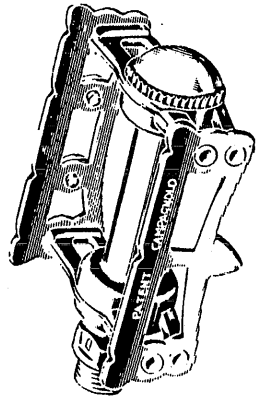

1036

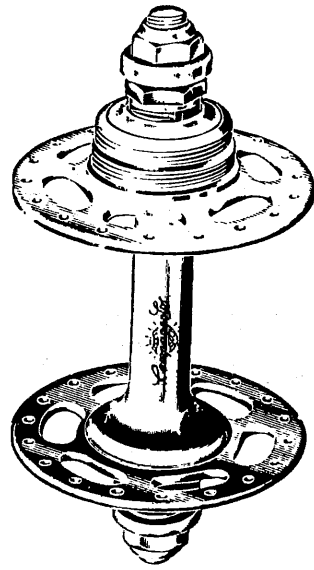

- 1036 Pair of Record track hubs (Specs: Holes—24 to 40; Threads—Eng., Fr., or Ital.)
- 1038 Pair of Record track pedals
- 1040 Record track head set (Specs: Eng., Fr., or Ital. Threads)

RECORD TRACK GROUP

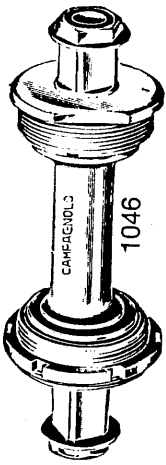

1046



2100

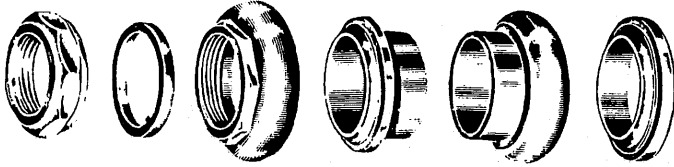

1040

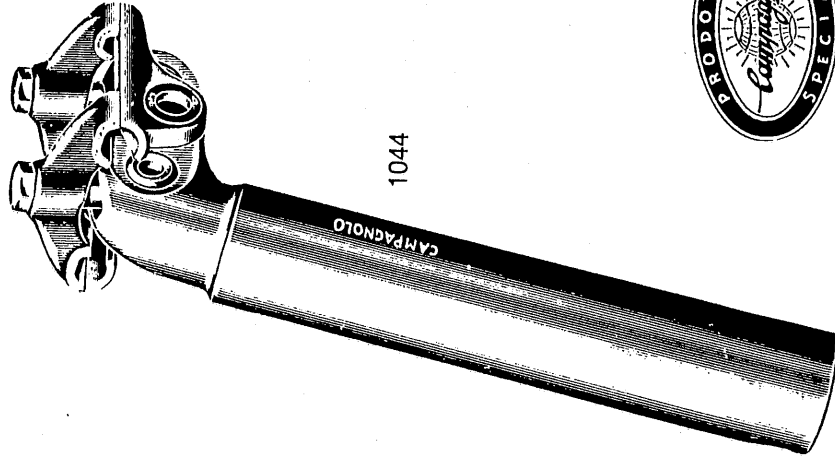

1044



1053



2102

1044 Seat pin for wide cradle saddles (please specify diameter and length as shown on pages 39 and 40. If requested, seat pin 1045 for narrow cradle saddles can be supplied.)

1046 Record bottom bracket set (Specs: See page 33)

1050 Track crankset w/BB (R)

1051 Track chainwheel set (chaining for chain 1/2" x 1/8" - Available also for chains 1" x 1/8" or 1" x 3/16" - Please specify number of chaining teeth and crank length - see page 27)

1053 Track fork ends (set of 4)

2100 Special ballraces for bottom bracket set

2102 Special ballraces for head set

2240 CAMPAGNOLO GRAN SPORT ROAD GROUP

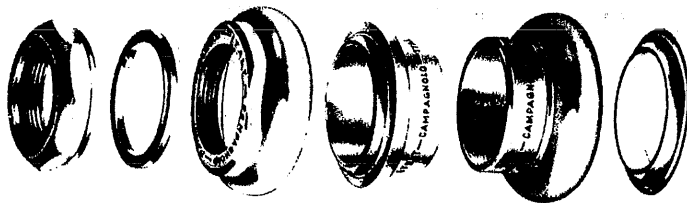
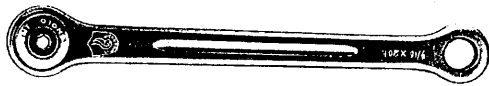
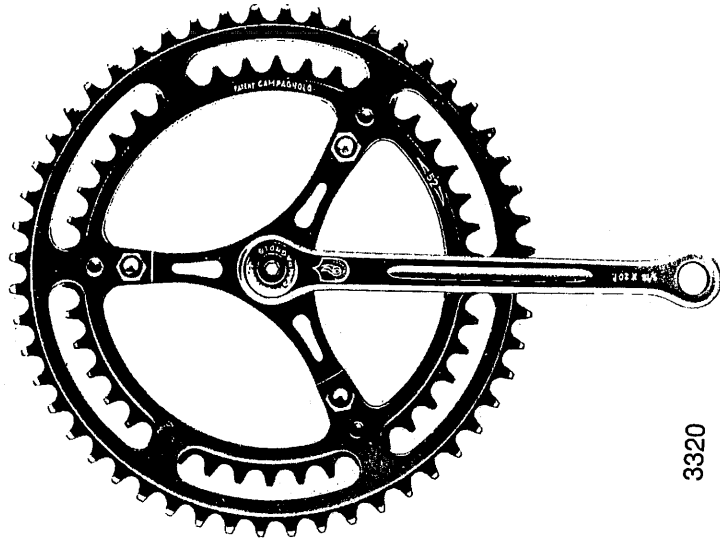

1040/A

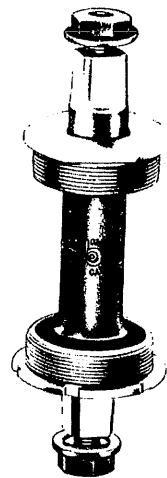

3331

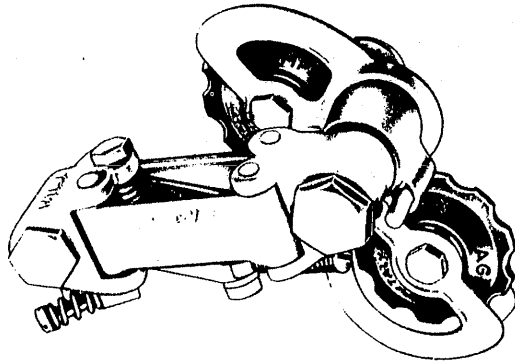

3500

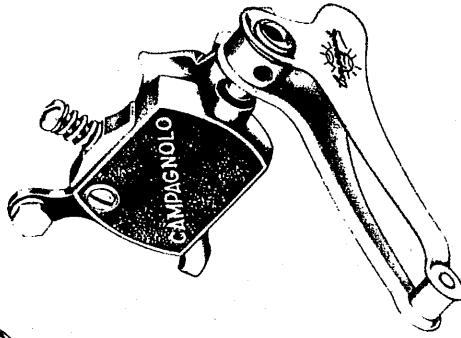

2050

- 606 Rear derailleur cable (118 cm)
- 608 Front derailleur cable (72 cm) (New Cable is 2 cm longer)

- 622 Rear derailleur stainless steel cable casing (21 cm)
- 626/A Dual derailleur cable guide
- 636 Cable stop C/S

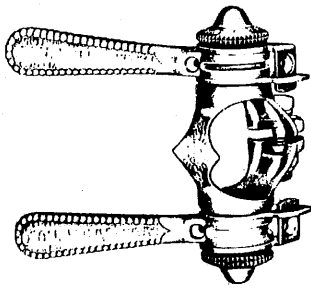

1014/1A

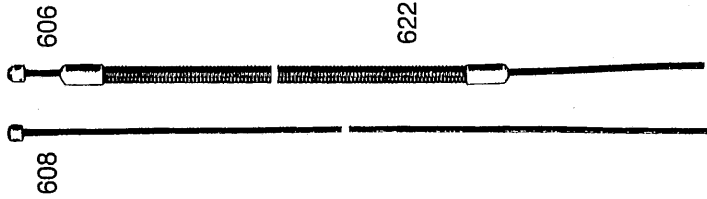

608

606

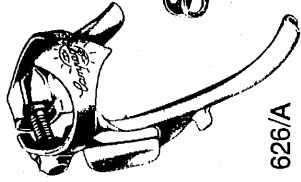

626/A

636

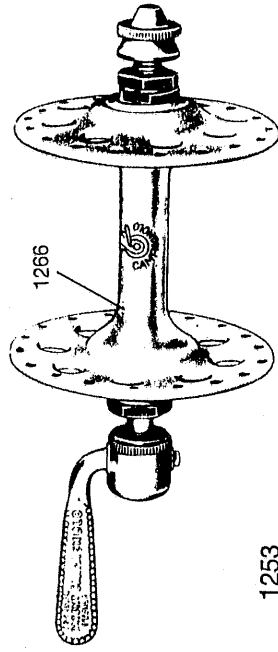

1266

1253



1010

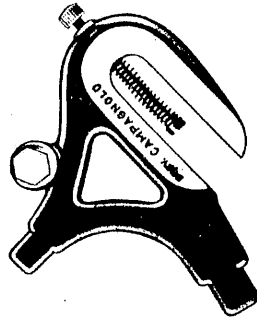

622

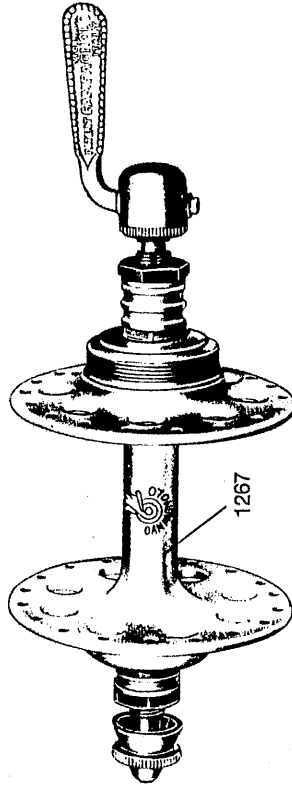

1267

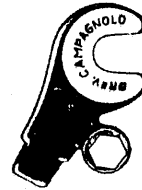
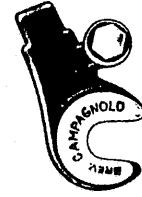

Valentino front derailleur (1052/1 may also be used)
 Sport road crankset w/o BB (Record BB will fit)(Specs: Page 30)
 Sport road crankset w/BB
 Sport bottom bracket set (Specs on pages 30, 33)
 Nuovo Gran Sport rear derailleur w/o hanger

2050
 3320
 3330
 3331
 3500

Road fork ends - set of 4 (R, NGS)
 Dual control (V, NGS)
 Sport road head set (Specs: Eng., Fr., or Ital. Thread)
 Pair large-flange road hubs (NT) (Specs: Holes-36;
 Thread-Eng. or Ital.)

1010
 1014/1A
 1040/A
 1253

- 89 Zinc-Plated bolt-int/w 676, 779
- 215 Cage end bolt for Spacer 790 (NR-Int/w 791)
- 217 Nut (General use)
- 773 Front derailleur body (R)
- 773/1 Front derailleur body clamp (R)
- 773/2 Front derailleur body clamp pin (R)
- 774 Front derailleur adjusting bolt (R)
- 775 Front derailleur adjusting spring (R)
- 776 Clip Fixing bolt
- 777 Clip fixing nut for Bolts 776 and 609/1
- 778 Front derailleur upper arm (R)
- 779 Cable bolt
- 780 Cable clamp washer for bolts 89 and 779
- 782 Front derailleur lower arm (R)
- 784 Front derailleur cage (R)
- 785 Front derailleur upper arm pivot pin sleeve (R)
- 786 Front derailleur upper arm pivot pin (R)
- 787 Front derailleur return spring (R)
- 788 Front derailleur lower arm pivot bolt (R)
- 789 Nut to fit bolt 788 (R)
- 790 Front derailleur cage rear spacer (R)
- 941 Front derailleur pivot arm C-clip (NR)

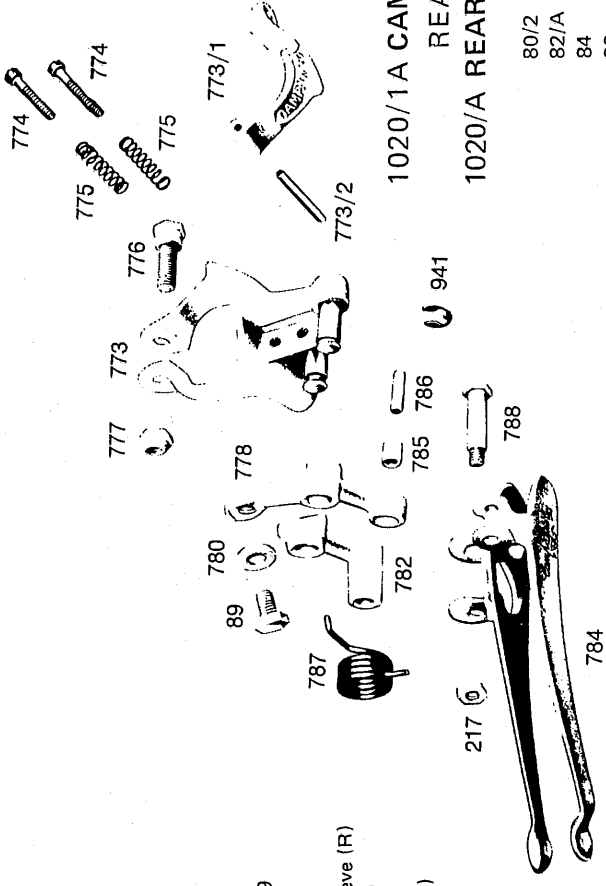

1020/1A CAMPAGNOLO NUOVO RECORD
REAR DERAILLEUR WITH HANGER
1020/A REAR DERAILLEUR WITHOUT HANGER

- 80/2 Rear derailleur hanger (SR, NR, NGS)
- 82/A Derailleur arm pivot pin sleeve (SR, NR, RL, NGS)
- 84 Return spring fixing bolt (SR, NR, NGS)
- 88 Cable clamp washer for bolt 89
- 93/A Roller axle bolt (SR, NR)
- 98/A Derailleur return spring (SR, NR, RL)
- 99 Derailleur adjusting screw (SR, NR, RL, NGS)
- 120 Lower tension spring for screw 99 (NR, RL, NGS)
- 120/1 Upper tension spring for screw 99 (NR, RL, NGS)
- 124 Bolt
- 125 Rear derailleur hanger nut
- 166/A Upper pivot bolt (NR)
- 805/A Upper body for rear derailleur (NR)
- 806/A Outer rear derailleur arm (NR)
- 807/A Inner rear derailleur arm (SR, NR, RL)
- 808/A Rear derailleur arm pivot pin (SR, NR, RL, NGS)
- 810/A Rear derailleur tension spring cage (NR, RL)
- 810/1A Rear derailleur tension spring cage face plate (SR, NR, RL, NGS)
- 811/A Tension spring bolt (NR, RL)
- 812/A Spring cage cover (NR, RL)
- 812/1A Spring cage cover stop pin (SR, NR, RL, NGS)
- 813/A Rear derailleur tension spring (SR, NR, RL, NGS)
- 814/A Outer cage plate (SR, NR)
- 815/A Inner cage plate (SR, NR)
- 930/A Derailleur roller (SR, NR)
- 931/A Roller bushing (SR, NR)
- 932/A Roller bushing cover (NGS, VO, "Old Style" NR replaced by cover 937)
- 937 "New" Roller bushing cover (SR, NR, RL)

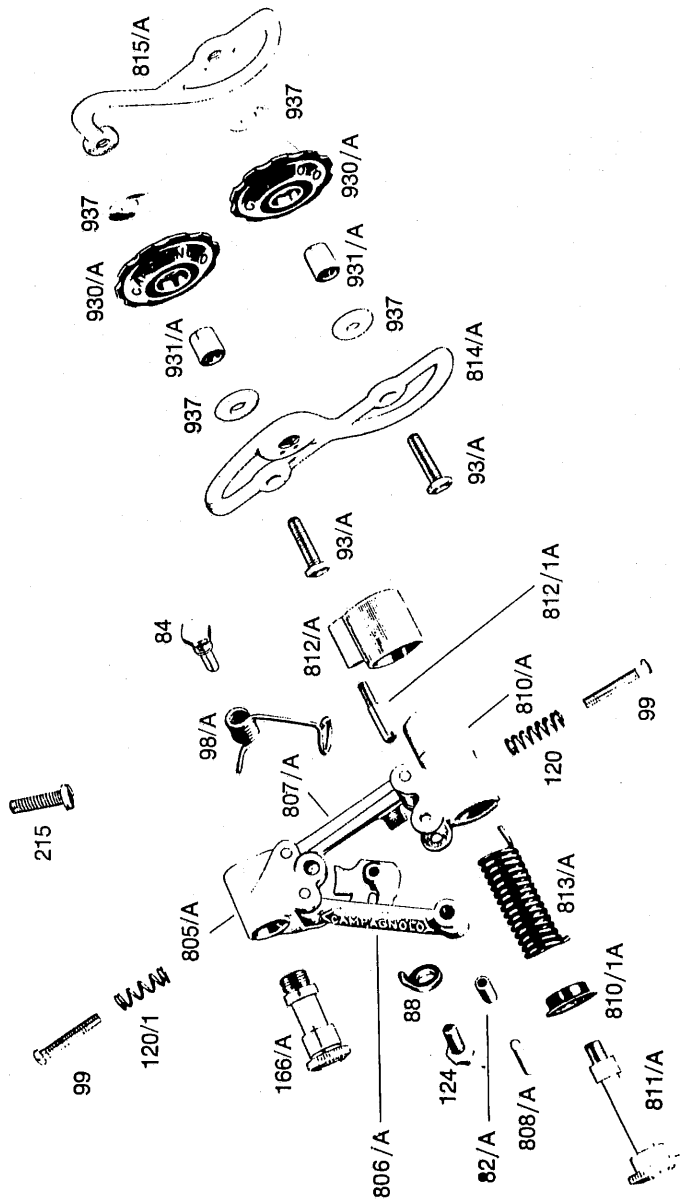

3450/1 CAMPAGNOLO RALLY REAR DERAILLEUR WITH HANGER
 3450 CAMPAGNOLO RALLY REAR DERAILLEUR WITHOUT HANGER

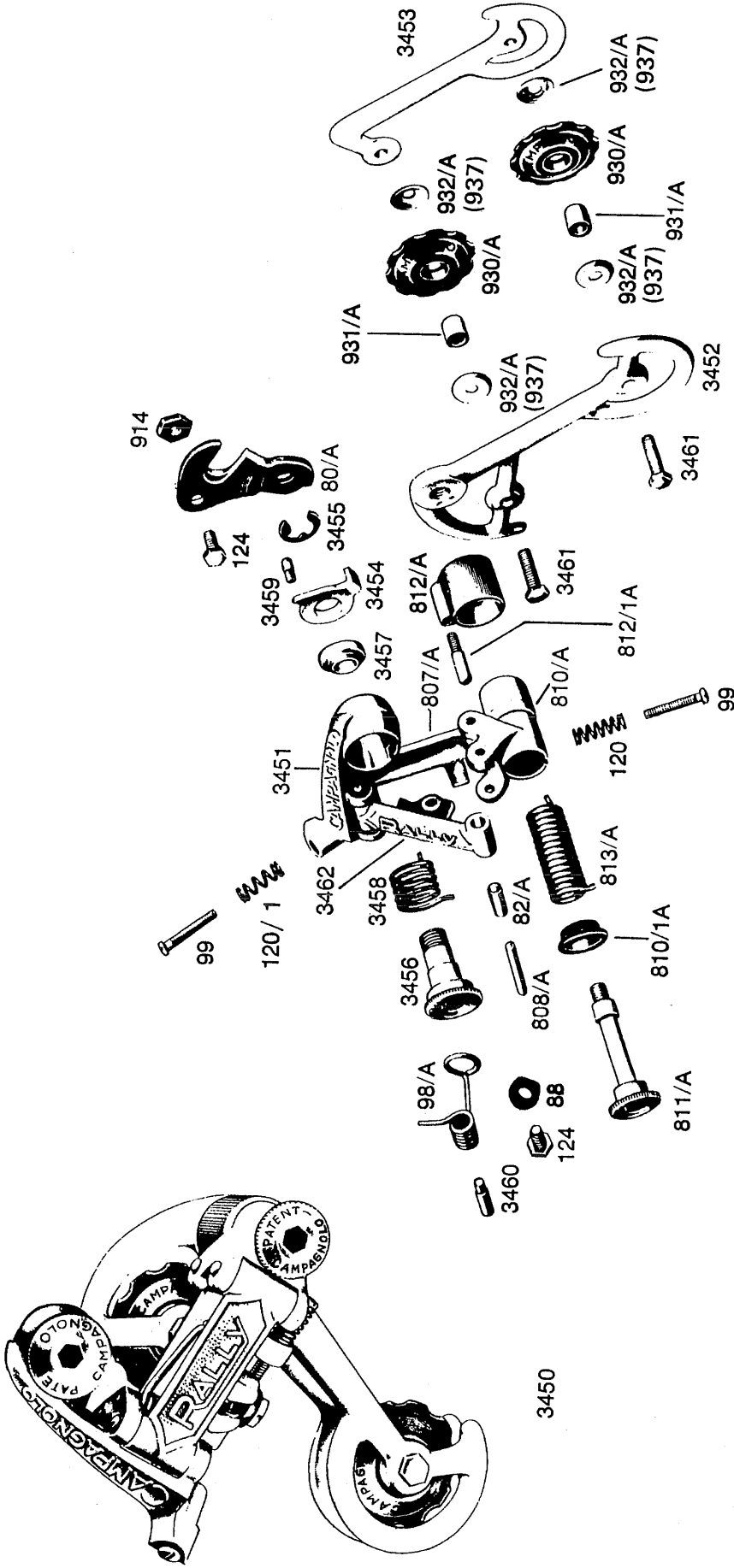

- 80/A Rear derailleur hanger (RL, VO, V)
- 82/A Derailleur arm pivot pin sleeve (SR, NR, RL, NGS)
- 88 Cable clamp washer for 89
- 99 Derailleur adjusting screw (SR, NR, RL, NGS)
- 98/A Derailleur return spring (SR, NR, RL)
- 120 Lower tension spring for 99 (NR, RL, NGS)
- 120/1 Upper tension spring for 99 (NR, RL, NGS)
- 124 Bolt
- 807/A Inner rear derailleur arm (SR, NR, RL)
- 808/A Rear derailleur arm pivot pin (SR, NR, RL, NGS)
- 810/A Rear derailleur tension spring cage (NR, RL)
- 810/1A Rear derailleur tension spring cage face plate (SR, NR, RL, NGS)
- 811/A Tension spring bolt (NR, RL)
- 812/A Spring cage cover (NR, RL)
- 812/1A Spring cage cover stop pin (SR, NR, RL, NGS)
- 813/A Rear derailleur tension spring (SR, NR, RL, NGS)
- 914 Nut for hanger bolt 124 (RL)
- 930/A Derailleur roller (NR)
- 931/A Roller bushing
- 932/A Roller bushing cover (All)
- 937 "New" Roller bushing cover (SR, NR, RL)
- 3451 Rear derailleur upper body (RL)
- 3452 Rear derailleur outer cage plate (RL)
- 3453 Rear derailleur inner cage plate (RL)
- 3454 Rear derailleur hanger stop plate (RL)
- 3455 Rear derailleur hanger bolt C clip (RL)
- 3456 Rear derailleur upper pivot bolt (RL)
- 3457 Rear derailleur upper spring cage plate (RL)
- 3458 Rear derailleur upper tension spring (RL)
- 3459 Rear derailleur hanger stop plate pin (RL)
- 3460 Rear derailleur return spring pin (RL)
- 3461 Rear derailleur roller axle bolt (RL)
- 3462 Rear derailleur outer arm (RL)

3500/1 CAMPAGNOLO NUOVO GRAN SPORT REAR DERAILLEUR WITH HANGER
 3500 CAMPAGNOLO NUOVO GRAN SPORT REAR DERAILLEUR WITHOUT HANGER

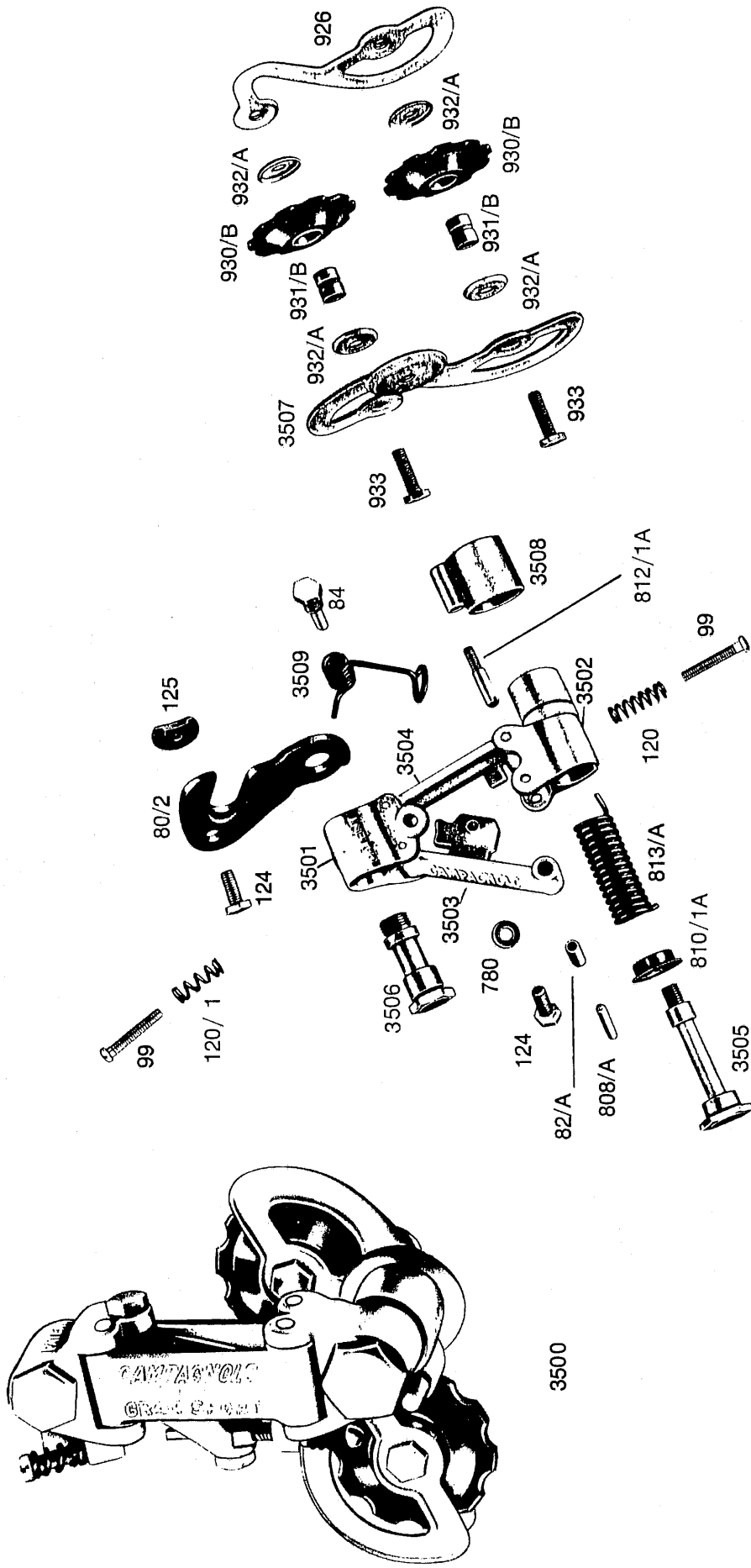

- | | | | |
|-------|---|--------|---|
| 80/2 | Rear derailleur hanger (SR, NR, NGS) | 780 | Cable clamp washer |
| 82/A | Derailleur arm pivot pin sleeve (SR, NR, RL, NGS) | 808/A | Rear derailleur arm pivot pin (SR, NR, RL, NGS) |
| 84 | Derailleur adjusting screw (SR, NR, RL, NGS) | 810/1A | Rear derailleur tension spring bushing (NR, RL) |
| 99 | Return spring fixing bolt (SR, NR, NGS) | 812/1A | Spring cage cover stop pin (NR, RL) |
| 120 | Derailleur adjusting screw (SR, NR, RL, NGS) | 813/A | Tension spring |
| 120/1 | Lower tension spring for 99 (NR, RL, NGS) | 926 | Inner cage plate (NGS, VO) |
| 124 | Upper tension spring for 99 (NR, RL, NGS) | 930/B | Derailleur roller (NGS, VO) |
| 124 | Bolt | 931/B | Roller bushing (NGS, VO) |
| 125 | Rear derailleur hanger nut (SR, NR, NGS) | 932/A | Roller bushing cover (All) |
| | | 933 | Roller axle bolt (NGS, VO) |
| | | 3501 | Rear derailleur upper body (NGS) |
| | | 3502 | Rear derailleur lower body (NGS) |
| | | 3503 | Rear derailleur outer arm (NGS) |
| | | 3504 | Rear derailleur inner arm (NGS) |
| | | 3505 | Rear derailleur tension spring bolt (NGS) |
| | | 3506 | Rear derailleur upper body pivot bolt (NGS) |
| | | 3507 | Rear derailleur outer cage plate (NGS) |
| | | 3508 | Rear derailleur spring cage cover (NGS) |
| | | 3509 | Rear derailleur return spring (NGS) |

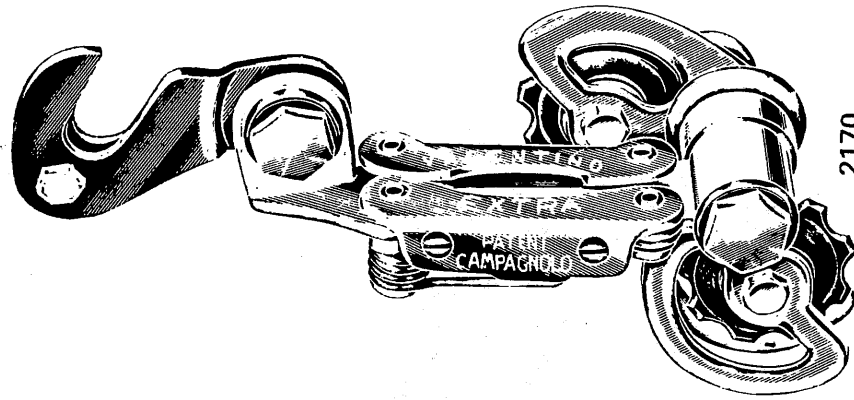
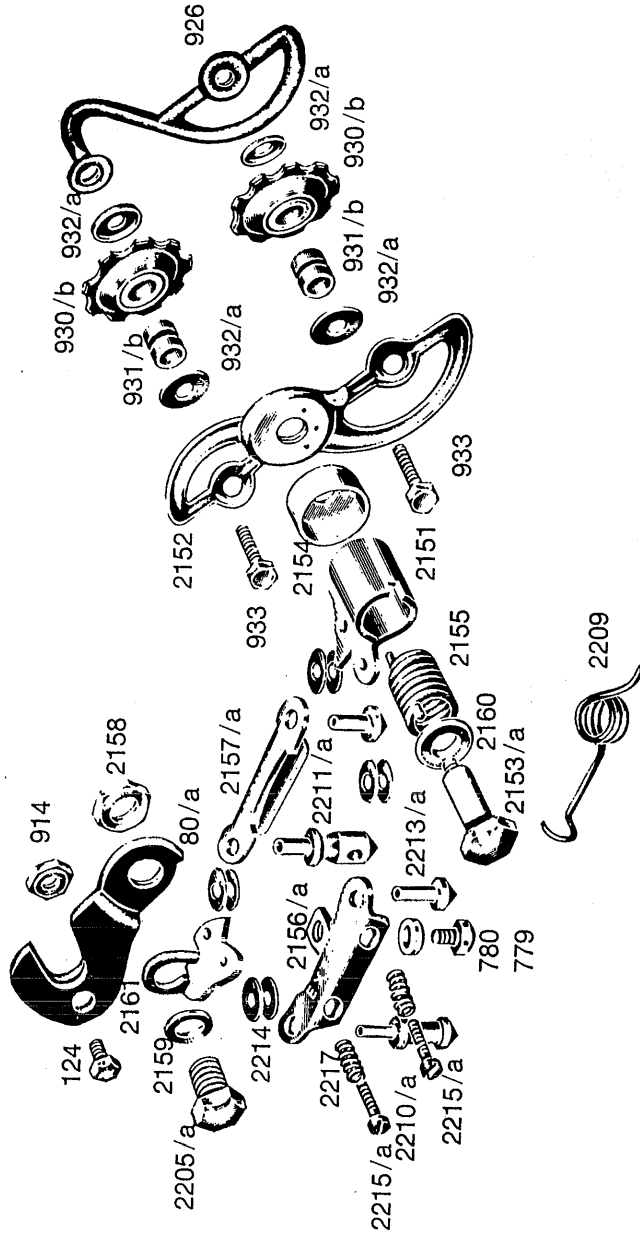

- | | |
|-------------------------------|------------------------------|
| 80'a Gear fixing plate | 2156/a Outer arm |
| 124 Fixing screw | 2157/a Inner arm |
| 779 Cable clamp screw | 2158 Gear counter fixing nut |
| 780 Cable clamp screw washer | 2159 Gear hanger bolt |
| 914 Nut for fixing plate bolt | 2160 Spring cage cover |
| 926 Inner cage plate | 2161 Rear body |
| 930'b Rollers | 2205'a Fixing pivot bolt |
| 931'b Roller bushes | 2209 Gear return spring |
| 932'a Roller dust cover | 2210'a Return spring spindle |
| 933 Roller bolt | 2211'a Spindle |
| 2151 Spring cage | 2213'a Arm rivets |
| 2152 Outer cage plate | 2214 Spring washer |
| 2153'a Spring cage bolt | 2215'a Adjusting bolt |
| 2154 Cover | 2217 Adjusting screw spring |
| 2155 Gear tension spring | |

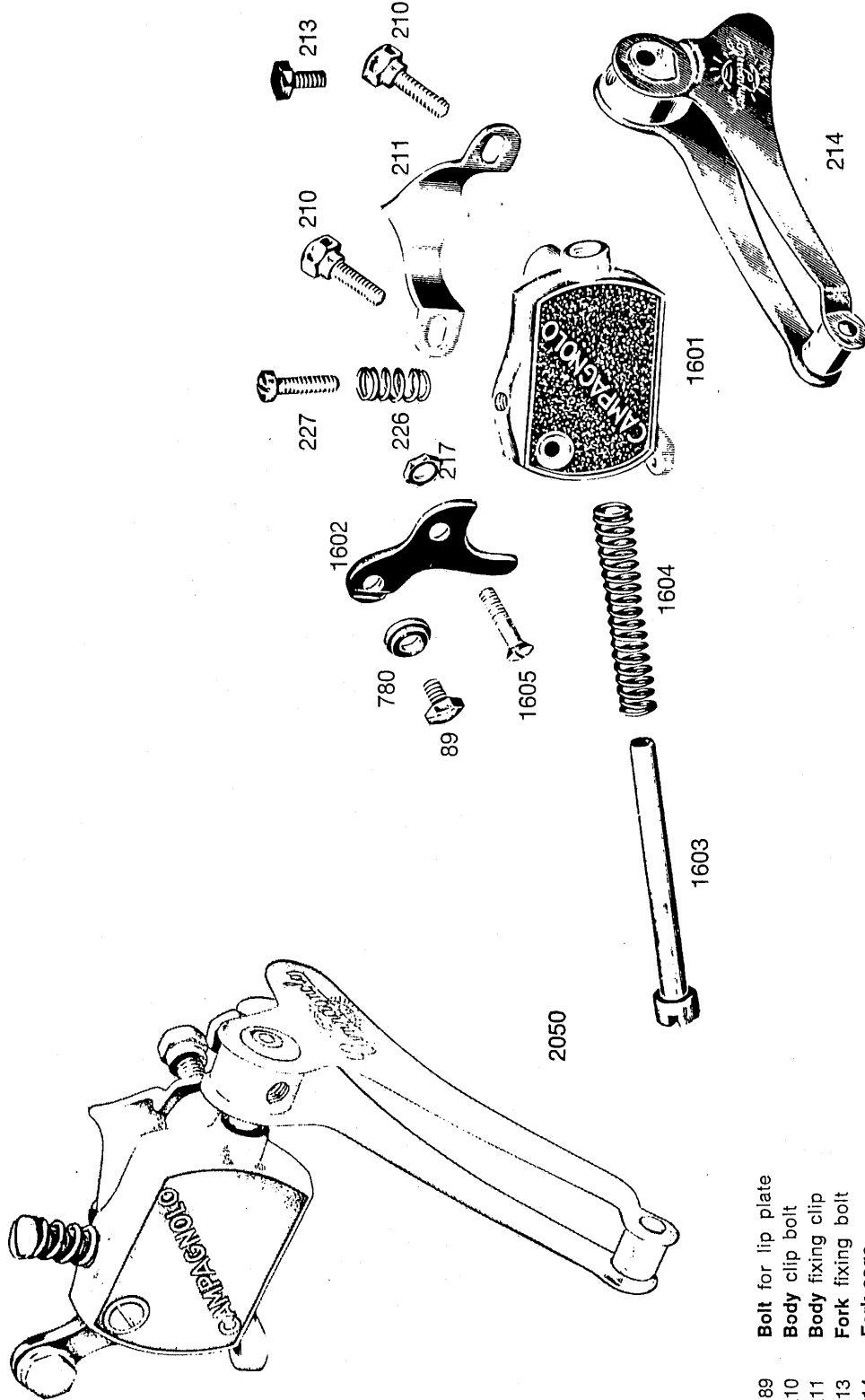

- 89 Bolt for lip plate
- 210 Body clip bolt
- 211 Body fixing clip
- 213 Body fixing bolt
- 214 Fork-cage
- 217 Nut for spacing screw bolt
- 226 Adjusting bolt spring
- 227 Adjusting lever screw
- 780 Cable clamp screw washer
- 1601 Front changer body
- 1602 Control fork
- 1603 Spindle
- 1604 Return spring
- 1605 Bolt

2250

CAMPAGNOLO VELOX
REAR DERAILLEUR

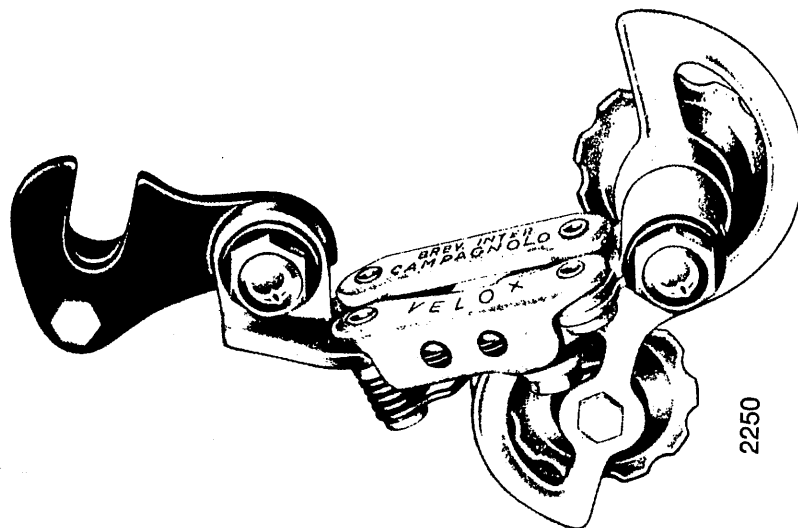

2250

2270

CAMPAGNOLO GRAN TURISMO
REAR DERAILLEUR

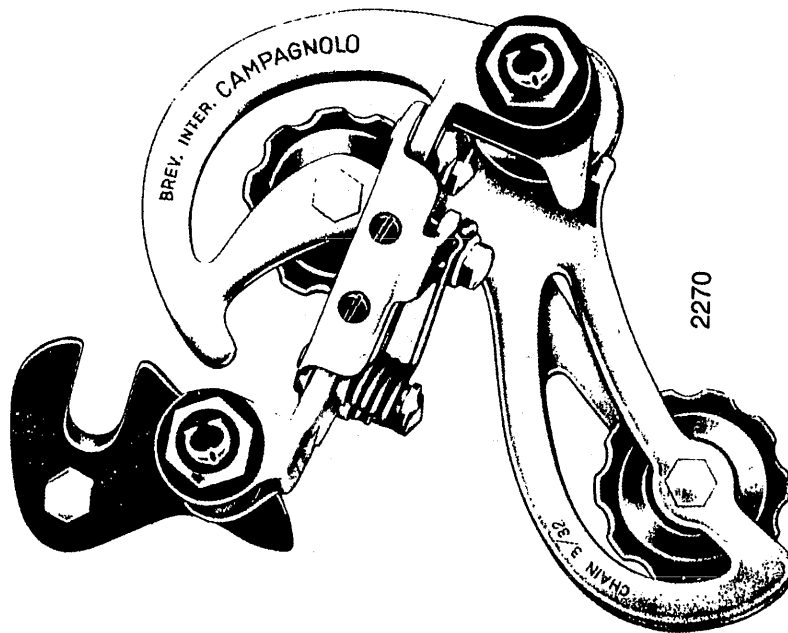

2270

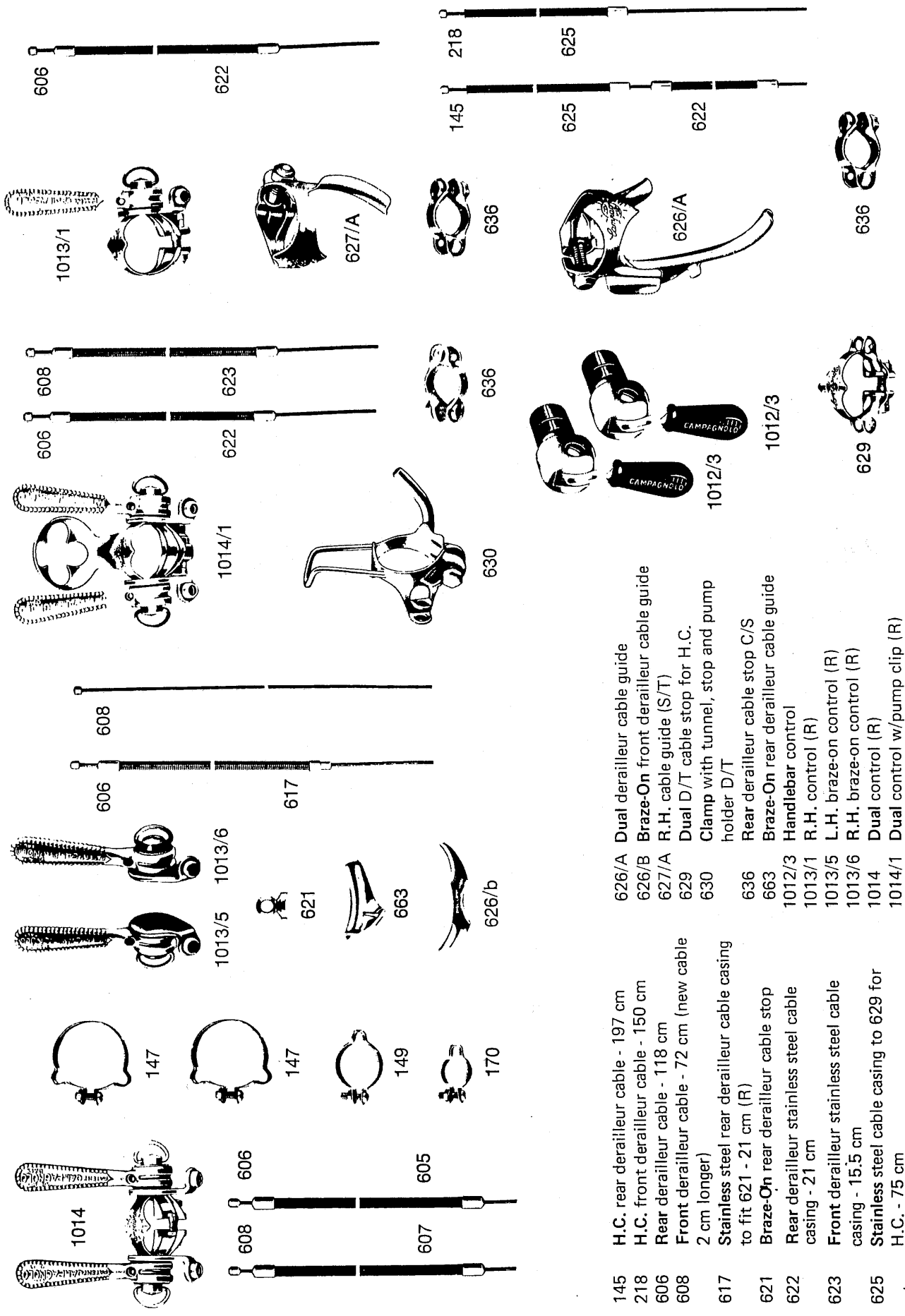

145 H.C. rear derailleur cable - 197 cm
 218 H.C. front derailleur cable - 150 cm
 606 Rear derailleur cable - 118 cm
 608 Front derailleur cable - 72 cm (new cable 2 cm longer)
 617 Stainless steel rear derailleur cable casing to fit 621 - 21 cm (R)
 621 Braze-On rear derailleur cable stop
 622 Rear derailleur stainless steel cable casing - 21 cm
 623 Front derailleur stainless steel cable casing - 15.5 cm
 625 Stainless steel cable casing to 629 for H.C. - 75 cm

626/A Dual derailleur cable guide
 626/B Braze-On front derailleur cable guide
 627/A R.H. cable guide (S/T)
 629 Dual D/T cable stop for H.C.
 630 Clamp with tunnel, stop and pump holder D/T
 636 Rear derailleur cable stop C/S
 663 Braze-On rear derailleur cable guide
 1012/3 Handlebar control
 1013/1 R.H. control (R)
 1013/5 L.H. braze-on control (R)
 1013/6 R.H. braze-on control (R)
 1014 Dual control (R)
 1014/1 Dual control w/pump clip (R)

1014 H.C. front derailleur
 1013/1 R.H. front derailleur
 1014/1 H.C. rear derailleur
 627/A R.H. cable guide (S/T)
 626/A Dual derailleur cable guide
 629 Dual control (R)
 1012/3 Handlebar control
 636 Rear derailleur cable stop C/S
 630 Clamp with tunnel, stop and pump holder D/T
 625 Stainless steel cable casing to 629 for H.C. - 75 cm

CAMPAGNOLO RECORD CONTROL LEVER PARTS

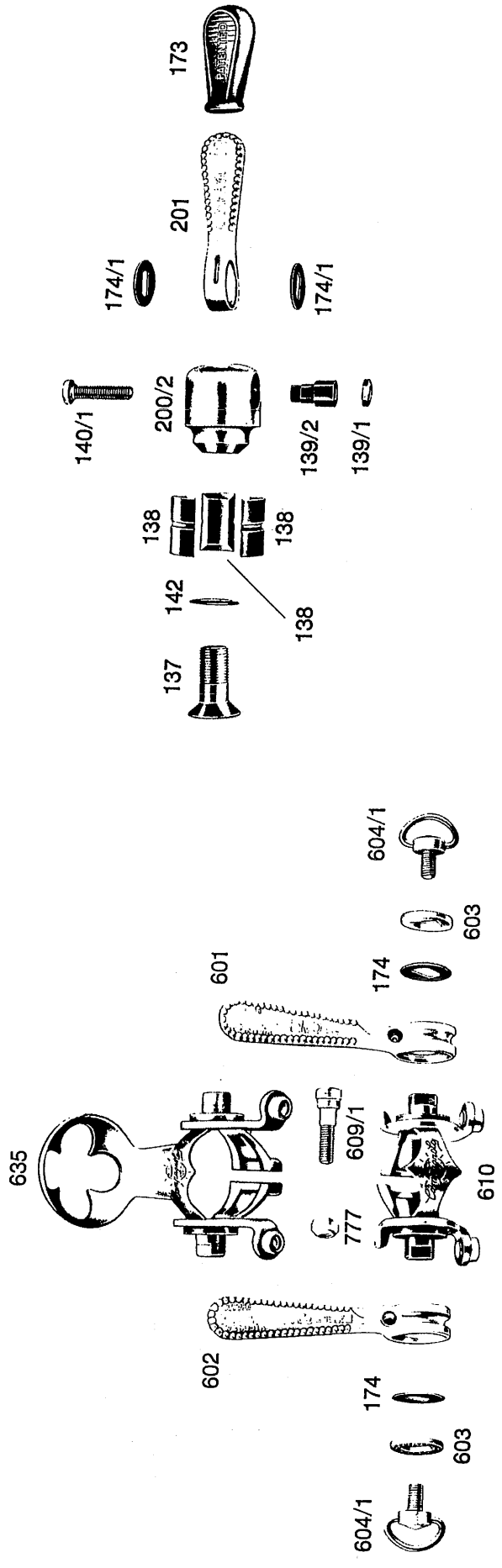

- 137 H.C. segment expander bolt
- 138 H.C. expander segment
- 139/1 H.C. tension adjusting lock nut
- 139/2 H.C. nut
- 140/1 H.C. bolt
- 142 H.C. segment holding spring
- 173 Plastic lever cover H.C.
- 174 Control lever friction washer (D/T)
- 174/1 H.C. friction washer
- 200/2 H.C. body
- 201 H.C. lever
- 600 R.H. control - clamp only (R)
- 600/2 R.H. control stop plate for 660 (R)
- 601 R.H. control - lever only (R, Braze-on)
- 602 L.H. control - lever only (R, Braze-on)
- 603 Friction washer cover plate (D/T control)
- 604/1 Friction adjusting wingnut
- 609 Control clamp bolt and nut (609/1 and 777)
- 609/1 Clamp bolt
- 610 Dual control clamp only (R)
- 611/2 L.H. control lever stop plate for 660 (R)
- 635 Dual control clamp only w/pump holder (R)
- 660 Braze-On control boss
- 661 Control boss collar for 660
- 777 Clip fixing nut for bolts 776 and 609/1

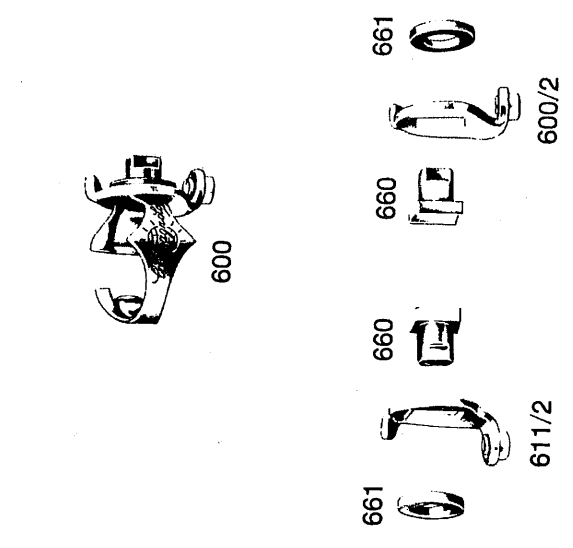

CAMPAGNOLO SPORT CONTROL LEVER PARTS

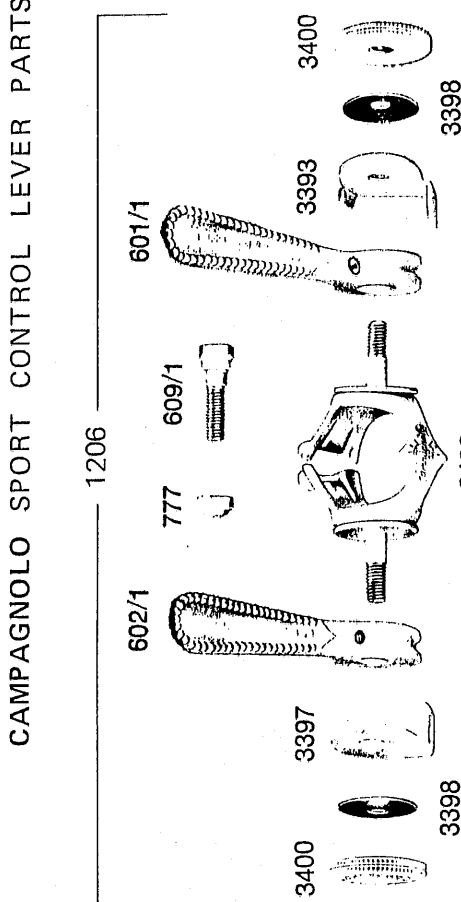

- 174 Control lever friction washer (D/T)
- 600/3 R.H. control stop plate for 660 (VO)
- 601 R.H. control - lever only (R, braze-on)
- 601/1 R.H. control - lever only (VO, V, SE, NGS)
- 602 L.H. control - lever only (R, braze-on)
- 602/1 L.H. control - lever only (VO, V, SE, NGS)
- 603 Friction washer cover plate (D/T control)
- 604 Friction adjusting screw (VO)
- 609 Control clamp bolt and nut (609/1 and 777)
- 609/1 Clamp bolt
- 611/3 L.H. control stop plate for 660 (VO)
- 660 Braze-On control boss
- 661 Control boss collar for 660
- 777 Clip fixing nut for bolts 776 and 609/1
- 1013/1A R.H. control complete (V)
- 1014/1A Dual control complete (V, NGS)
- 1204 R.H. control complete (VO)
- 1206 Dual control complete (VO)
- 1207 R.H. braze-on control (VO)
- 1208 L.H. braze-on control (VO)
- 3393 R.H. control stop plate (New VO)
- 3396 Control tension adjusting nut (NGS)
- 3397 L.H. control stop plate (New VO)
- 3398 Control friction washer (New VO, NGS)
- 3400 Control tension adjusting nut (New VO)
- 3401 Dual control clamp only (NGS)
- 3402 R.H. control clamp only (NGS)
- 3403 Dual control clamp only (New VO)
- 3404 R.H. control clamp only (New VO)

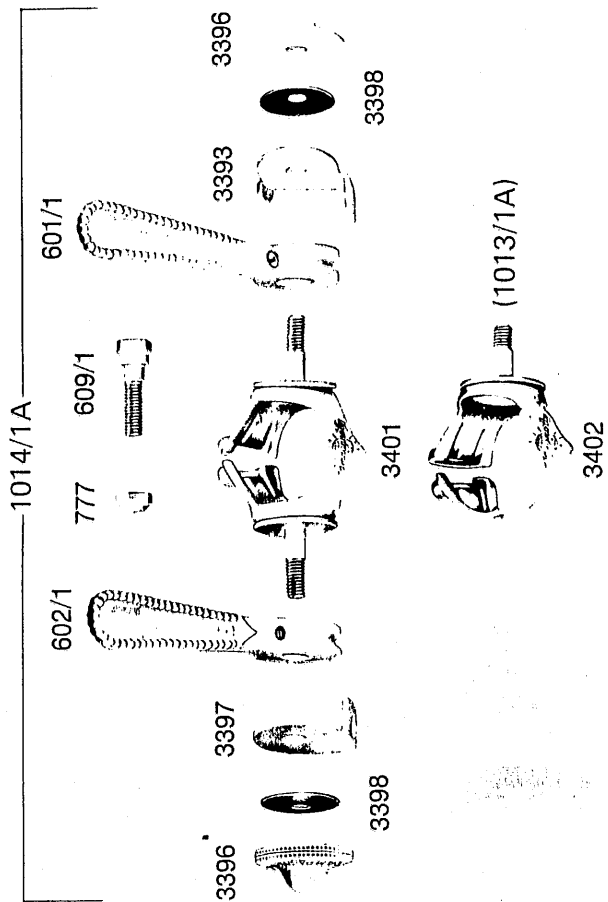

CAMPAGNOLO SUPER RECORD HUBS AND PARTS

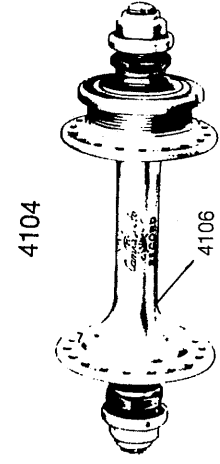
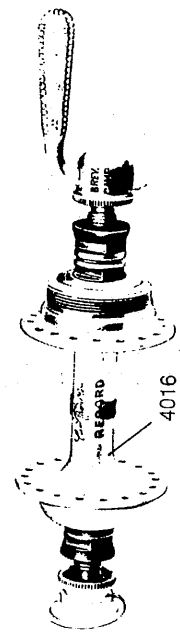
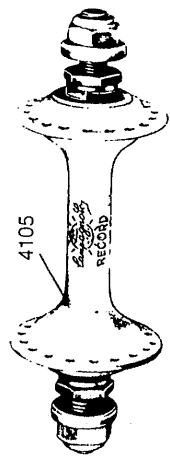
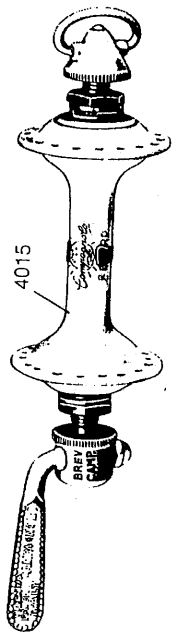

(NOTE: Super Record high-flange hubs on pages 3 and 6)

4104 Pair super record low-flange track hubs
(Specs: Holes-24 to 40; Threads-Eng., Fr., or Ital.)
4105 Front low-flange track hub (SR)
4106 Rear low-flange track hub (SR)
4014 Pair super record low-flange road hubs
(Specs: Holes-24 to 40; Threads-Eng., Fr., or Ital.)
4015 Front low-flange road hub (SR)
4016 Rear low-flange road hub (SR)

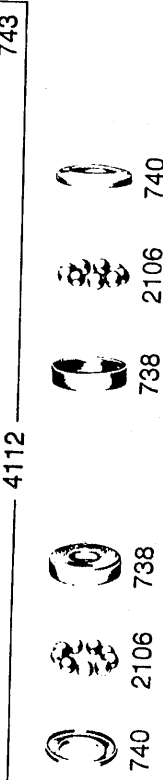
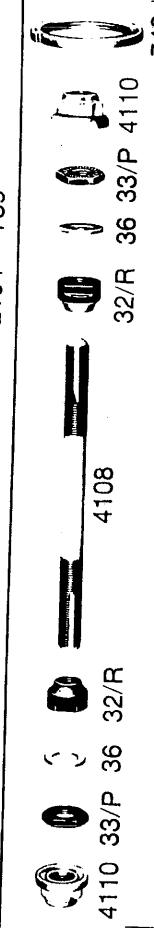
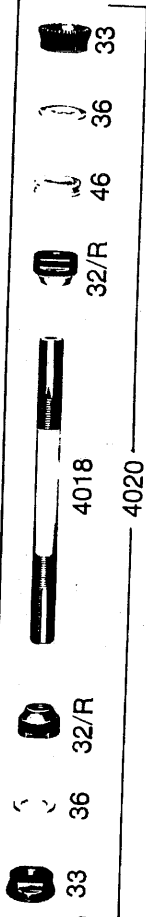
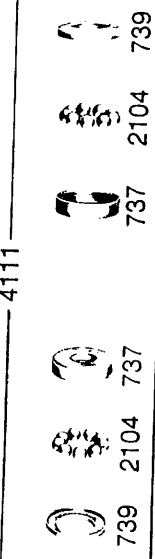
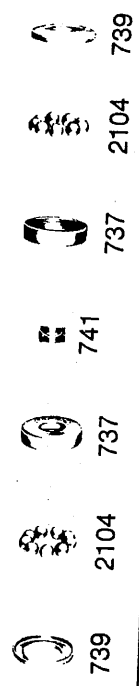
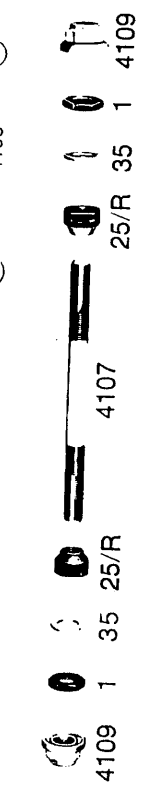
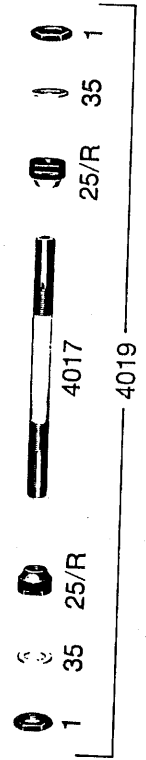

1 Front axle lock nut (All)
25/R Front axle cone
32/R Rear axle cone
33 Rear road axle lock nut
33/P Rear track axle lock nut
35 Front axle tongued washer (All)
36 Rear axle tongued washer (All)
46 Rear road axle spacer

737 Front hub inserted race (All-SR, R)
738 Rear hub inserted race (All-SR, R)
739 Front hub dust cover (All-SR, R)
740 Rear hub dust cover (All-SR, R)
741 Hub oil hole cap (SS-Front and Rear)
743 Track sprocket lock ring (Specs: Threads-Eng, Fr., or Ital.)
2104 Bearing balls for front hubs (R, SR)
2106 Bearing balls for rear hubs (All)

4017 Front road axle only (SR)
4018 Rear road axle only (SR)
4019 Front road axle complete (SR)
4020 Rear road axle complete (SR)
4107 Front track axle only (SR)
4108 Rear track axle only (SR)
4109 Front track axle nut (SR)
4110 Rear track axle nut (SR)
4111 Front track axle complete (SR)
4112 Rear track axle complete (SR)

1034 RECORD SMALL FLANGE CAMPAGNOLO QUICK RELEASE ROAD HUBS

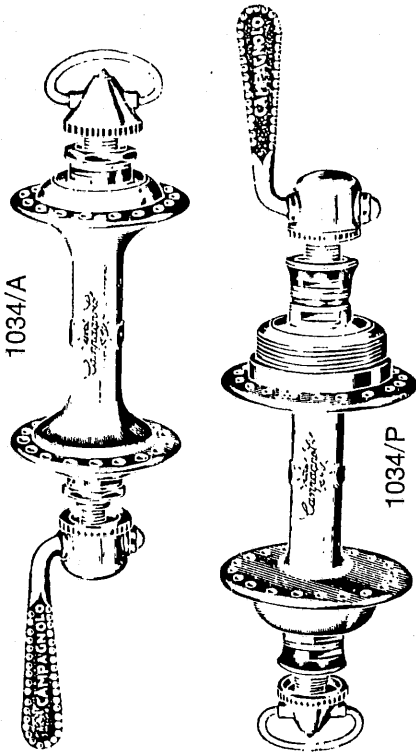

1035 RECORD LARGE FLANGE CAMPAGNOLO QUICK RELEASE ROAD HUBS

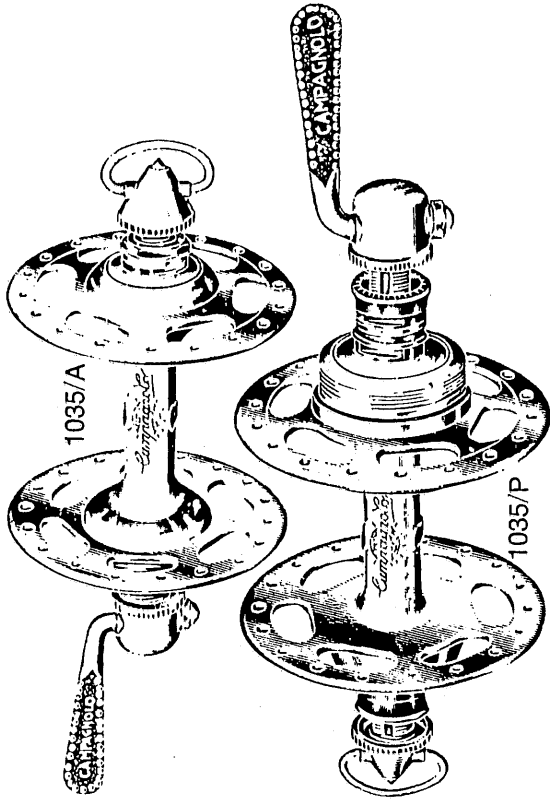

1036 RECORD LARGE FLANGE SOLID SPINDLE TRACK HUBS

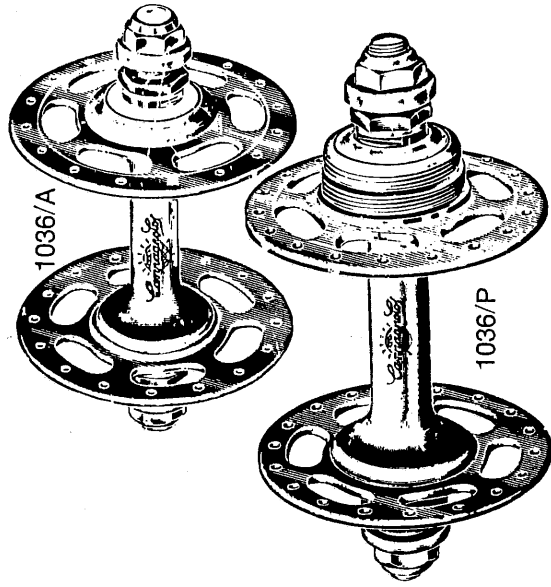

1036/2 RECORD SMALL FLANGE SOLID SPINDLE TRACK HUBS

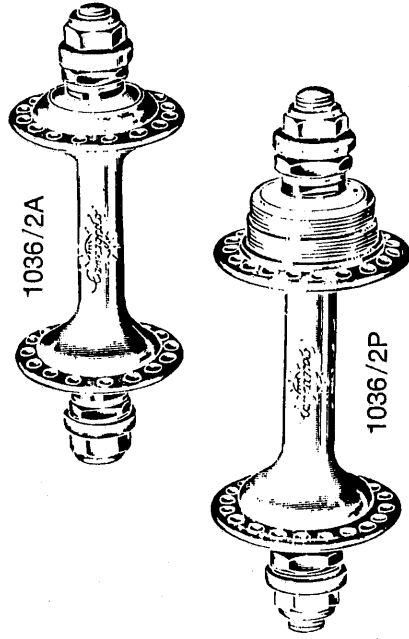

WHEN ORDERING PLEASE SPECIFY: { THREAD (Ø 35 X 24 F. OR Ø 34,7 X 1 OR Ø 1.370 X 24 F.) | HUBS ORDERED WITHOUT SPECIFICATION WILL BE SUPPLIED WITH Ø 1.370 X 24 F. AND WITH 36 HOLES

SIX-SPROCKET HUBS ALSO AVAILABLE

CAMPAGNOLO RECORD HUB PARTS

FRONT

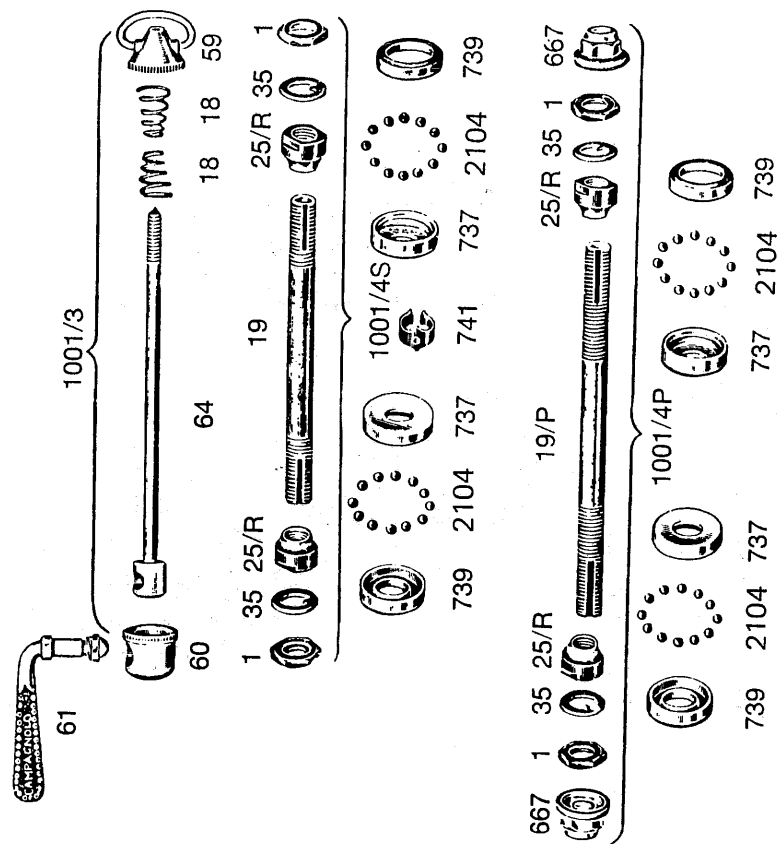

- 1 Front lock nut
- 18 Conical spring
- 19 Front road axle for Record road hubs
- 19 P Front track solid spindle axle
- 25 R Record front cone
- 29 Rear road axle for Record road hubs
- 29 P Rear track solid spindle
- 32 R Record rear cone
- 33 Rear lock nut for Record road hubs
- 33 P Rear lock nut for Record track hubs
- 35 Front spindle washer
- 36 Rear spindle washer

REAR

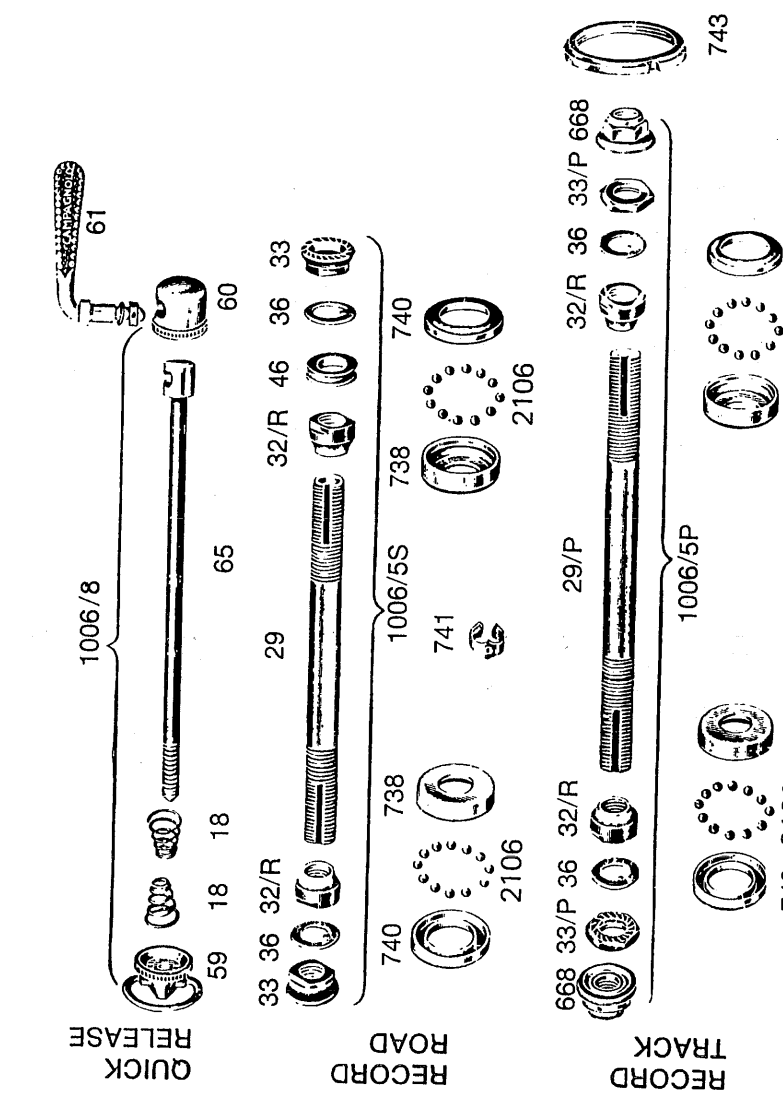

- 46 Rear spacing collar
- 59 Quick release conical adjuster
- 60 Quick release lever housing
- 61 Complete quick release lever
- 61/1 Quick release lever washer (SR, NR)
- 61/2 Quick release lever nut (SR, NR)
- 64 Quick release front skewer
- 65 Quick release rear skewer
- 667 Track front nut
- 668 Track rear nut
- 737 Front Record ball cup
- 738 Rear Record ball cup
- 739 Front dust cover
- 740 Rear dust cover
- 741 Spring clip
- 743 Track lock ring
- 1001/3 Front quick release skewer complete
- 1001/4P Front track axle complete
- 1001/4S Front road axle complete
- 1006/5P Rear track axle complete
- 1006/5S Rear road axle complete
- 1006/5S Rear road axle complete for 6-speed (must specify)
- 1006/8 Rear quick release skewer complete
- 2104 Bearing balls for front hubs (R, SR)
- 2106 Bearing balls for all rear hubs

1251 NUOVO TIPO SMALL FLANGE CAMPAGNOLO
QUICK RELEASE HUBS

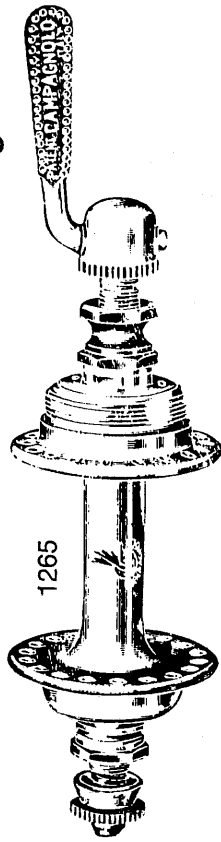
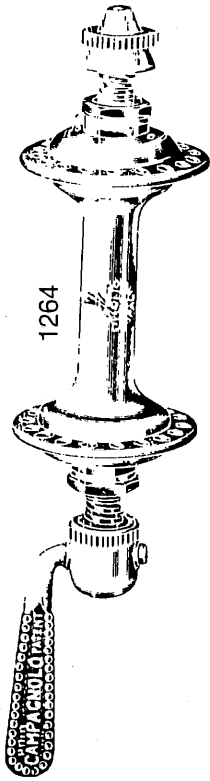

1250 NUOVO TIPO SMALL FLANGE CAMPAGNOLO
SOLID SPINDLE HUBS

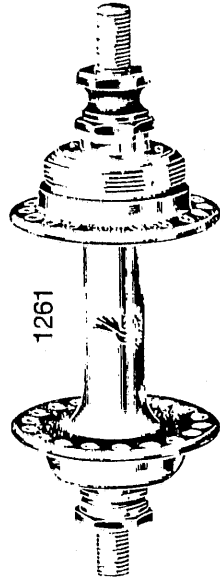
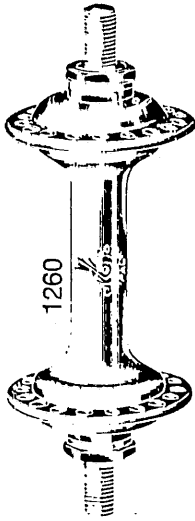

1253 NUOVO TIPO LARGE FLANGE CAMPAGNOLO
QUICK RELEASE HUBS

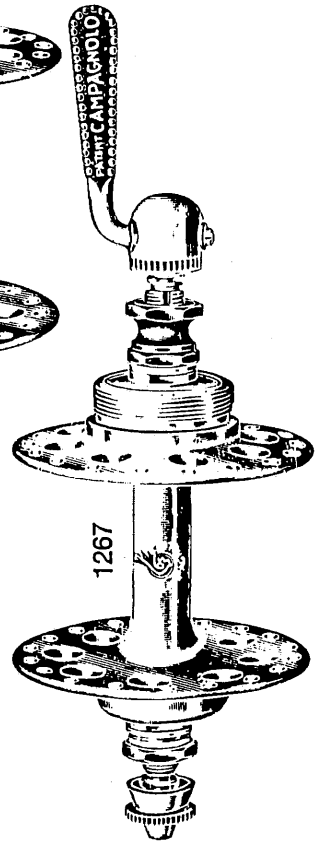
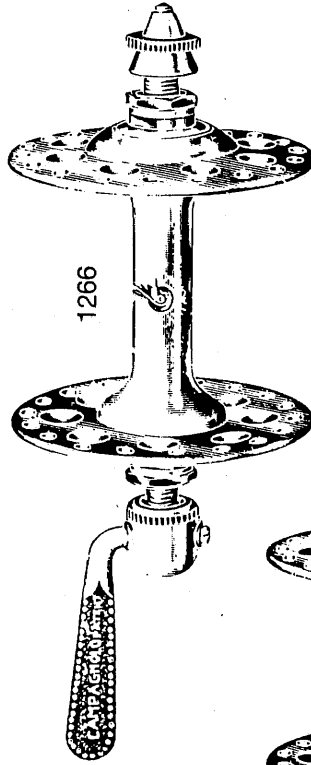

1252 NUOVO TIPO LARGE FLANGE CAMPAGNOLO
SOLID SPINDLE HUBS

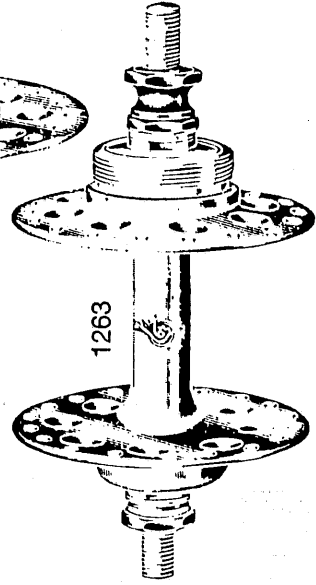
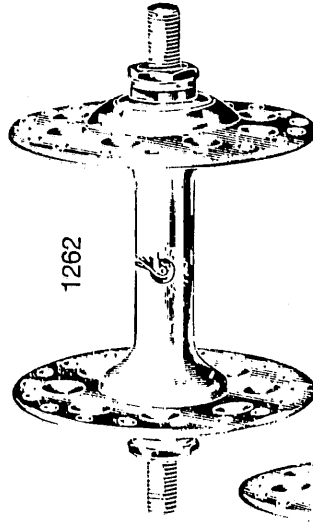

WHEN ORDERING PLEASE SPECIFY: { THREAD (Ø 35 X 24 F. OR Ø 34,7 X 1 OR Ø 1.370 X 24 F.) | HUBS ORDERED WITHOUT SPECIFICATION WILL BE SUPPLIED
NUMBER OF HOLES (24 - 28 - 32 - 36 - 40) | WITH 2 1.370 X 24 F. AND WITH 36 HOLES

CAMPAGNOLO NUOVO TIPO HUB PARTS

FRONT

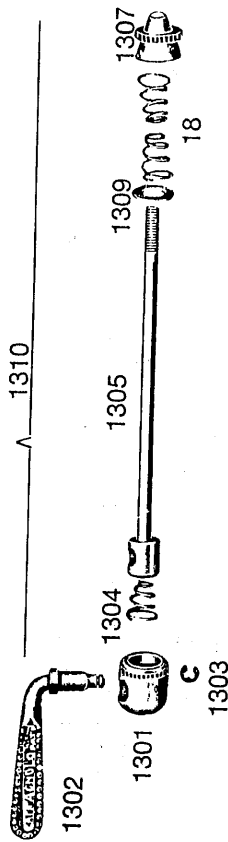

REAR

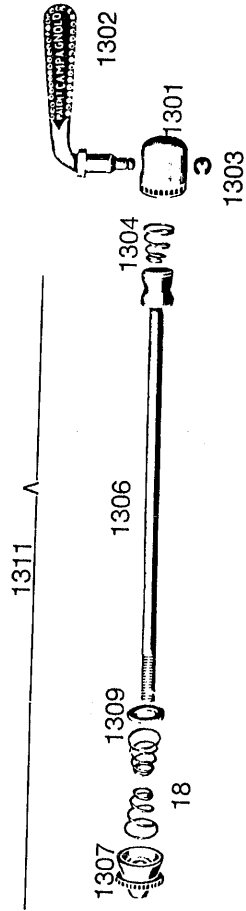

QUICK RELEASE

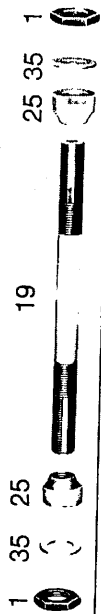

QUICK RELEASE
NUOVO TIPO

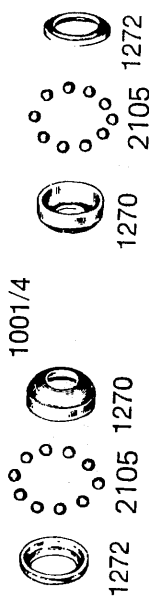

FRONT SPINDLE
NUOVO TIPO

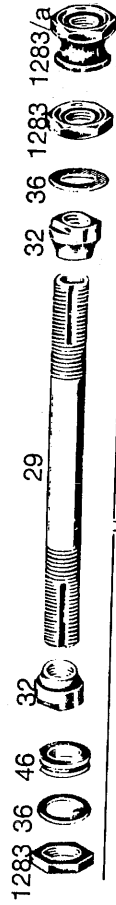

REAR SPINDLE
NUOVO TIPO

- 1 Front lock nut
- 18 Conical spring
- 19 Front road axle
- 25 Front road axle cone
- 29 Rear road axle
- 32 Rear Record cone
- 35 Front spindle washer
- 36 Rear spindle washer
- 46 Rear spacing collar
- 1001/4 Complete front hollow spindle for Nuovo Tipo hubs
- 1254 Complete front solid spindle for Nuovo Tipo hubs
- 1255 Complete rear solid spindle for Nuovo Tipo hubs
- 1256 Complete rear hollow spindle for Nuovo Tipo hubs
- 1270 Front inserted race

- 1271 Rear inserted race
- 1272 Front dust cap
- 1273 Rear dust cap
- 1278 Spindle front washer
- 1279 Spindle rear washer
- 1280 Front spindle
- 1281 Rear spindle
- 1282 Front locknut
- 1283 Rear locknut
- 1283/a Rear spacer nut
- 1284 Rear locknuts
- 1284/a Spindle special nut
- 1285 Large spacing collar
- 1286 Small spacing collar

- 1289 Front spindle cone
- 1290 Rear spindle cone
- 1301 Chrome cam cap
- 1302 Quick release lever
- 1303 Circlip for lever
- 1304 Conical spring
- 1305 Front skewer
- 1306 Rear skewer
- 1307 Knurled adjusting nut
- 1309 Washer for skewer
- 1310 Nuovo Tipo front quick release skewer
- 1311 Nuovo Tipo rear quick release skewer
- 2105 Front hub bearings
- 2106 Rear hub bearings

CAMPAGNOLO SUPER RECORD AND RECORD CRANKSET PARTS

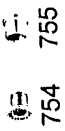

754



752



801



756

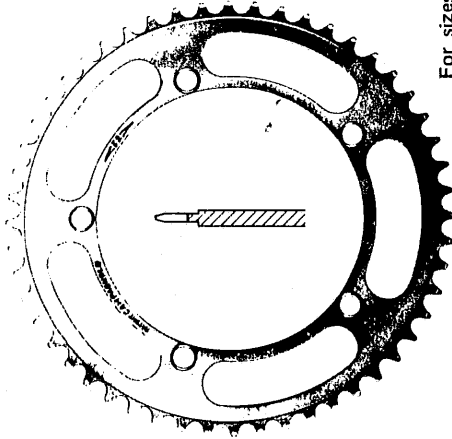

753

ROAD

For sizes and details of bottom bracket sets, see pages 30-33.

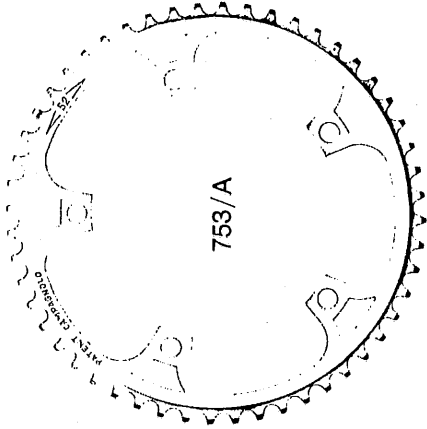

753/A

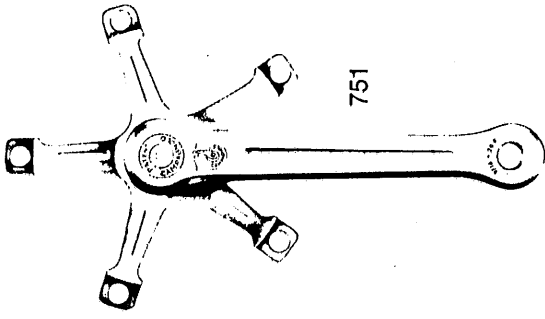

751

IMPORTANT:
When ordering spare Road chainrings, specify if they are to be fitted on crank spider for chainrings with 42 teeth and up or from 44 teeth and up.

TRACK

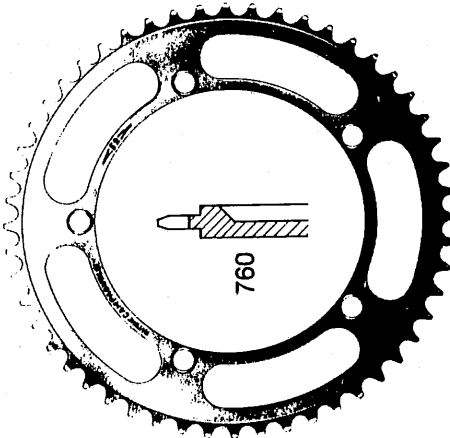

760

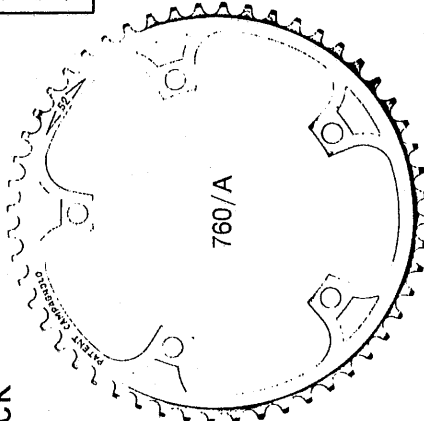

760/A

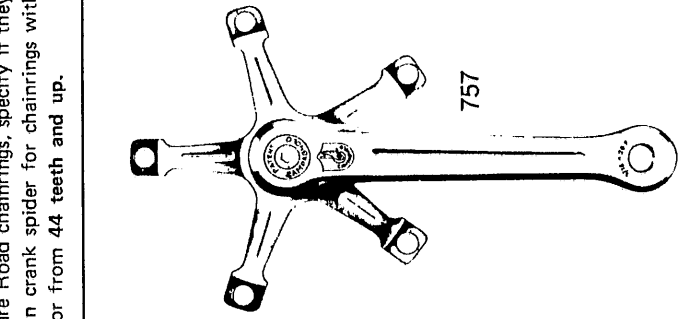

757

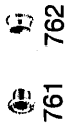

761

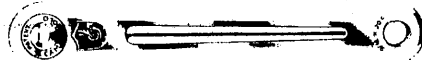

758



756

- 751 Road R.H. crank w/cover 756 (R)
- 752 Road L.H. crank w/cover 756 (R)
- 753 Road chainring (R)
- 753/a Road chainring (SR)
- 754 Road chainwheel fastening screw
- 755 Road chainwheel fastening nut
- 756 Crank cover plate (All)
- 757 Track R.H. crank w/cover 756
- 758 Track L.H. crank w/cover 756
- 760 Track chainring (R)
- 760/a Track chainring (SR)
- 761 Track chainwheel fastening screw
- 762 Track chainwheel fastening nut
- 801 Spacer for single road chainring

CRANK LENGTHS: 165, 167.5, 170, 172.5, 175, 177.5, 180 mm

ROAD CHAINRINGS: FOR 1/2" x 3/32" CHAIN - FROM 42 TO 57 TEETH

TRACK CHAINRINGS: FOR 1" x 1/8" (OR 3/16") CHAIN - FROM 22 TO 35 TEETH

FOR 1/2" x 1/8" CHAIN - FROM 44 TO 70 TEETH

CAMPAGNOLO ROAD SPECIAL CHAINWHEEL
SPARE PARTS

SPARE PARTS

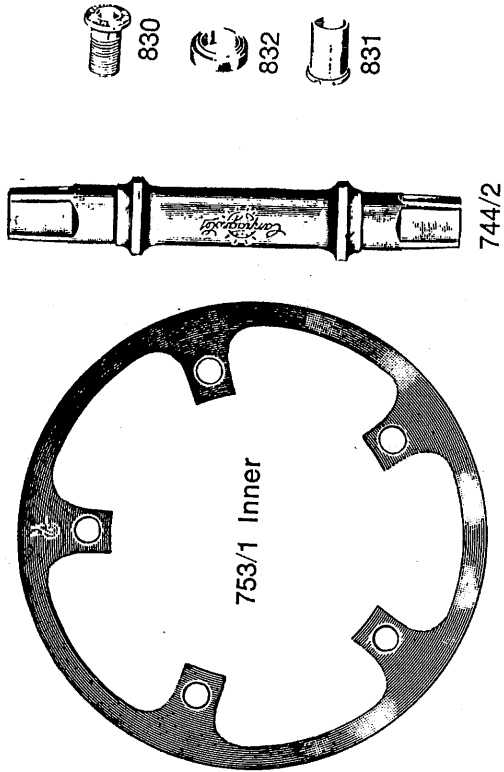

- 744/2 Cyclocross cotterless spindle (Specs on page 33)
- 751 Road R.H. crank w/cover 756 (R)
- 753 Road chainring for 1/2" x 3/32" (2 mm) chain - 42 to 57 teeth (R)
- 753/1 Cyclocross inner flange
- 753/2 Cyclocross outer flange
- 830 Triple chainring fixing bolt
- 831 Nut for bolt 830
- 832 Triple chainring spacer

CAMPAGNOLO CYCLOCROSS RIGHT HAND CRANK
WITH PROTECTIVE FLANGES

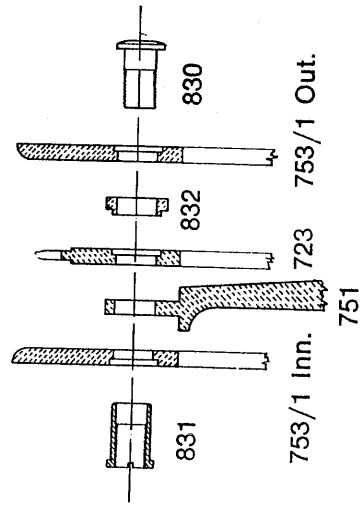
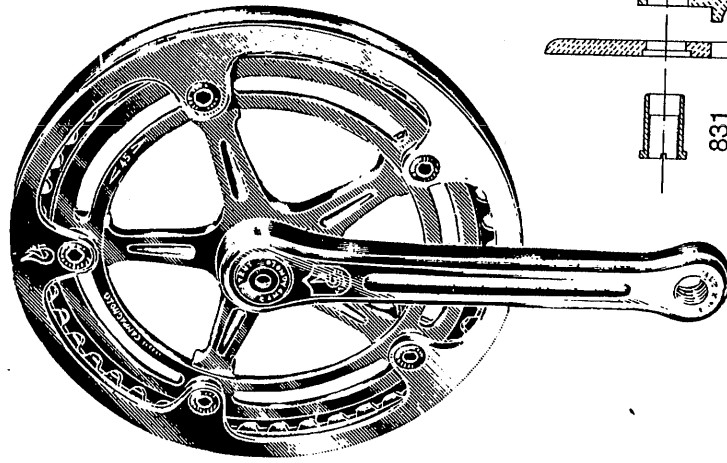

CAMPAGNOLO TRIPLE CRANKSET CONVERSIONS

STANDARD TRIPLE CONVERSION

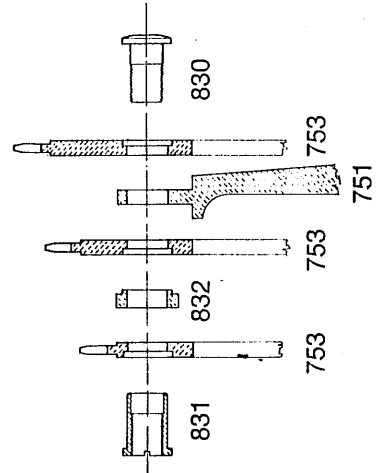
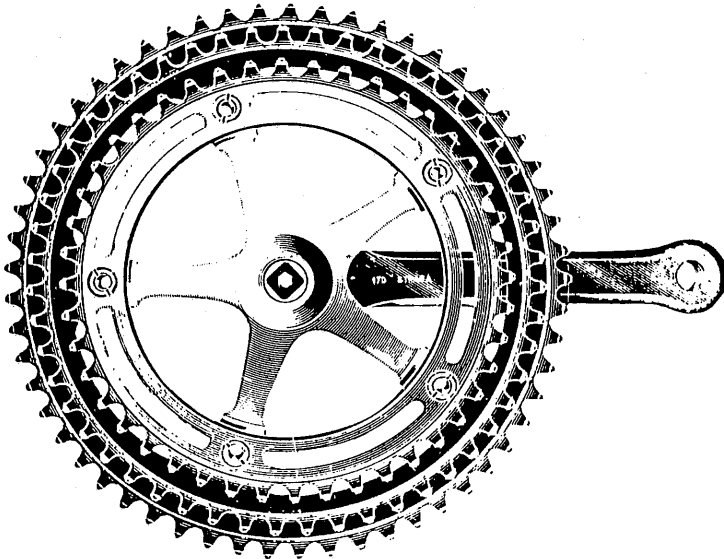

- 744/1 Triple cotterless spindle - see specs page 33
- 751 Road R.H. crank w/cover 756 (R)
- 752 Road L.H. crank w/cover 756 (R)
- 753 Road chainring for 1/2" x 3/32" (2 mm) chain - 42 to 57 teeth (R)
- 754 Road chainwheel fastening screw
- 755 Road chainwheel fastening nut
- 756 Crank cover plate (All)

SPECIAL TRIPLE CONVERSION

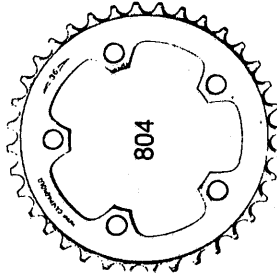
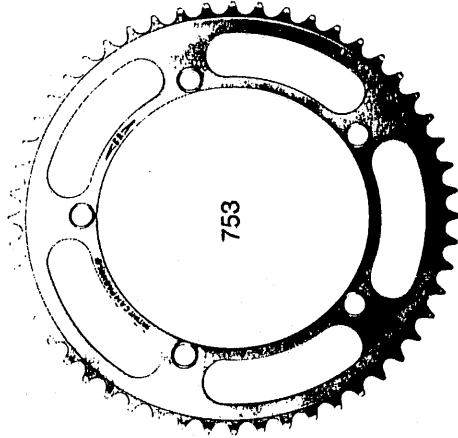

- 761 Track chainwheel fastening screw
- 804 36-Tooth chainring for special triple conversion
- 818 Chainwheel spacer (to fit 804 to 819)
- 819 R.H. crank (to fit 36-tooth chainring 804) (Available in 170 mm ONLY)
- 830 Triple chainring fixing bolt
- 831 Nut for bolt 830
- 832 Triple chainring spacer

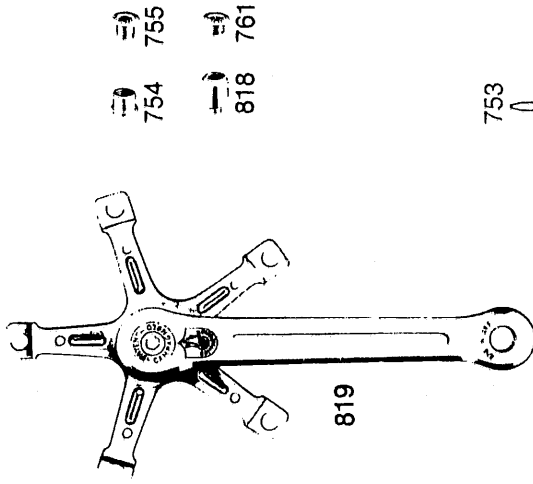

- 754 Bolt
- 755 Nut
- 818 Bolt
- 761 Nut

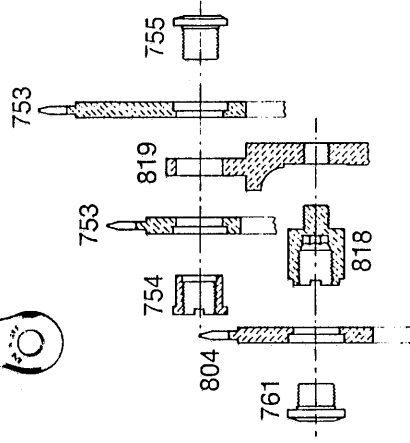

- 753 Track chainwheel fastening screw
- 754 Bolt
- 761 Nut
- 755 Nut
- 818 Chainwheel spacer (to fit 804 to 819)
- 819 R.H. crank (to fit 36-tooth chainring 804) (Available in 170 mm ONLY)
- 830 Triple chainring fixing bolt
- 831 Nut for bolt 830
- 832 Triple chainring spacer

- 3320 CAMPAGNOLO SPORT ROAD CRANKSET WITHOUT BOTTOM BRACKET
- 3330 CAMPAGNOLO SPORT ROAD CRANKSET WITH BOTTOM BRACKET

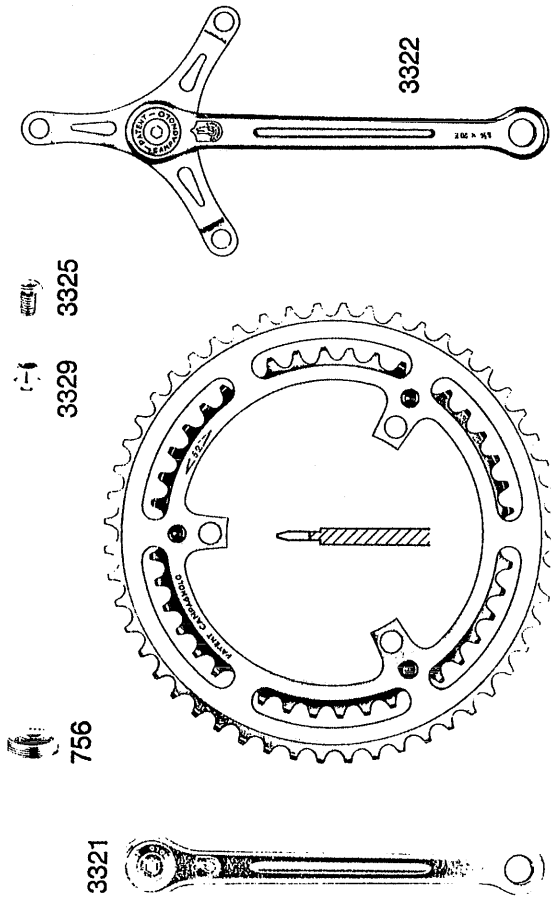

3329 3325

756

3321

3322

- 3331 CAMPAGNOLO SPORT BOTTOM BRACKET SET

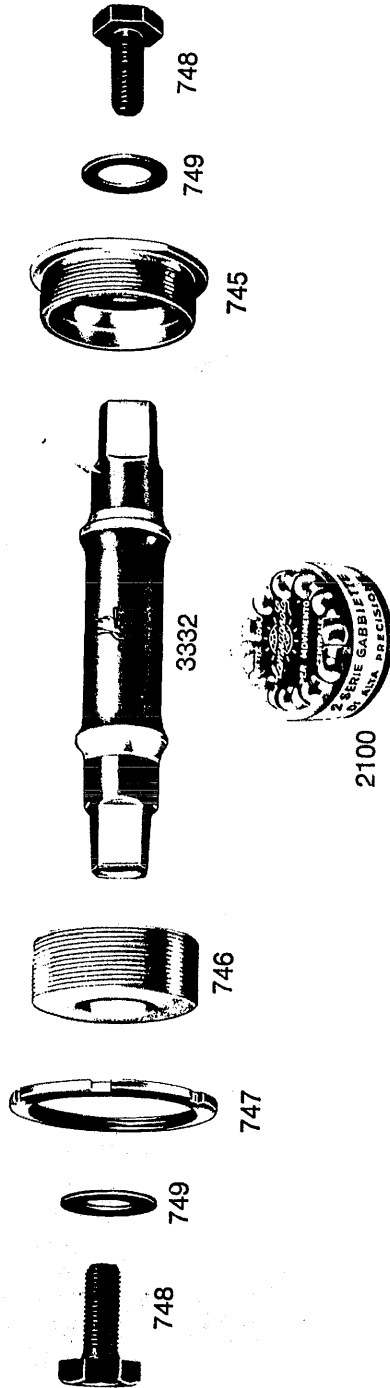

748 749

747

746

3332

745

749

748

2100

BOTTOM BRACKET SETS AVAILABLE IN 68-SS-120 AND 70-SS-120 ONLY (OTHER SPECS ON PAGE 33)

- 745 Fixed bottom bracket cup (R, S) (Specs: Threads—Eng., Fr., or Ital.)
- 746 Adjustable bottom bracket cup (R, S) (Specs: Threads—Eng., Fr., or Ital.)
- 747 Bottom bracket locking (All) (Specs: Threads—Eng., Fr., or Ital.)
- 748 Spindle end bolt (All)
- 749 Spindle end washer (All)
- 756 Crank cover plate (All)
- 2100 Bearings for bottom bracket set (R)
- 3320 Sport road crankset w/o bottom bracket (Specs: Teeth combinations—42/49, 42/50, 42/51, 42/52, 42/53 and 43/52)
- 3321 Sport L.H. crank w/cover 756 (170 mm ONLY)
- 3322 Sport R.H. crank w/cover 756 (170 mm ONLY)
- 3325 Sport chainring fixing bolt
- 3327 Sport road double chainring set (Specs: Teeth combinations—42/49, 42/50, 42/51, 42/52, 42/53, 43/52)
- 3329 Sport chainring nut for 3325
- 3330 Sport road crankset w/bottom bracket (Specs: See 3320 above and page 33)
- 3332 Bottom bracket road spindle (S) (Specs: See page 33)

4031 CAMPAGNOLO SUPER RECORD ROAD BOTTOM BRACKET SET

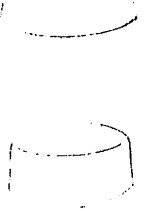

2110/1



4035



748



749



747



4034



4032

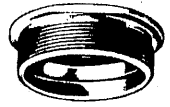

4033



749



748

AVAILABLE IN SPINDLE SIZES 68-SS-120 AND 70-SS-120 ONLY (OTHER SPECS ON PAGE 33)

4131 CAMPAGNOLO SUPER RECORD TRACK BOTTOM BRACKET SET



747



4134



748



749



4132



4133



749



748



4035

AVAILABLE IN ALL TRACK SPINDLE SIZES (OTHER SPECS ON PAGE 33)

- 747 Bottom bracket locking (All) (Specs: Threads—Eng., Fr., or Ital.)
- 748 Spindle end bolt (All)
- 749 Spindle end washer (All)
- 2110 Plastic bottom bracket protector (SR, NR)
- 2110/1 Plastic bottom bracket protector end cone for 2110 (SR, NR)
- 4032 Titanium road spindle (SR) (Specs: 68-SS-120 or 70-SS-120 ONLY; Other specs on page 33)
- 4033 Road bottom bracket fixed cup (SR) (Specs: Threads—Eng., Fr., or Ital.)
- 4034 Road bottom bracket adjustable cup (SR) (Specs: Threads—Eng., Fr., or Ital.) (Swiss cup available on special order only)
- 4035 Bearings for Super Record bottom bracket set
- 4132 Titanium track spindle (SR) (Specs: See page 33)
- 4133 Track bottom bracket fixed cup (SR) (Specs: Threads—Eng., Fr., or Ital.)
- 4134 Track bottom bracket adjustable cup (SR) (Specs: Threads—Eng., Fr., or Ital.)

1046/A CAMPAGNOLO NUOVO RECORD BOTTOM BRACKET SET PARTS

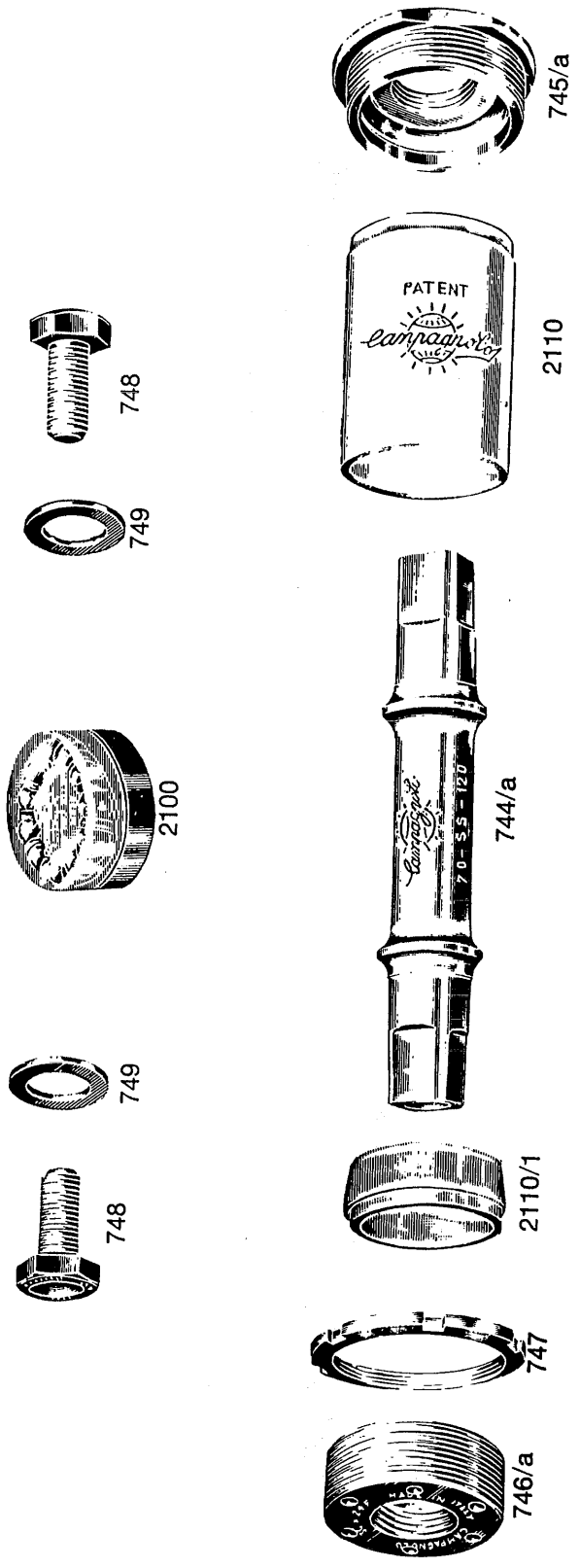

1046/a AND 744/a AVAILABLE IN 68-SS-120 AND 70-SS-120 ONLY (OTHER SPECS ON PAGE 33)

CUPS WITH A 0.5 mm. INCREASED THREAD AVAILABLE

Details of the bracket serial number (ex. 68-SS-120)

- the number (68) indicates the width
- (SS) indicate road
- the number (120) indicates the suggested width of the rear hub for a perfect chain line (see pages 51-53)

BRACKET SETS ORDERED WITHOUT SPECIFICATION WILL BE SUPPLIED AS FOLLOWS:

- 68-SS-120 axle
- cups thread \varnothing 1.370" X 24 F.

- 744 a Cotterless road spindle
- 745 a Fixed cup*
- 746 a Adjustable cup
- 747 Lockring 3.5 mm. standard size (available also in 4 and 4.5 mm.)
- 748 Fixing screw
- 749 Fixing washer
- 2100 Bottom bracket special ball races
- 2110 Record sleeve
- 2110.1 Cone for Record sleeve

* Swiss cup available on special order only

1046 CAMPAGNOLO BOTTOM BRACKET SET SPECIFICATIONS

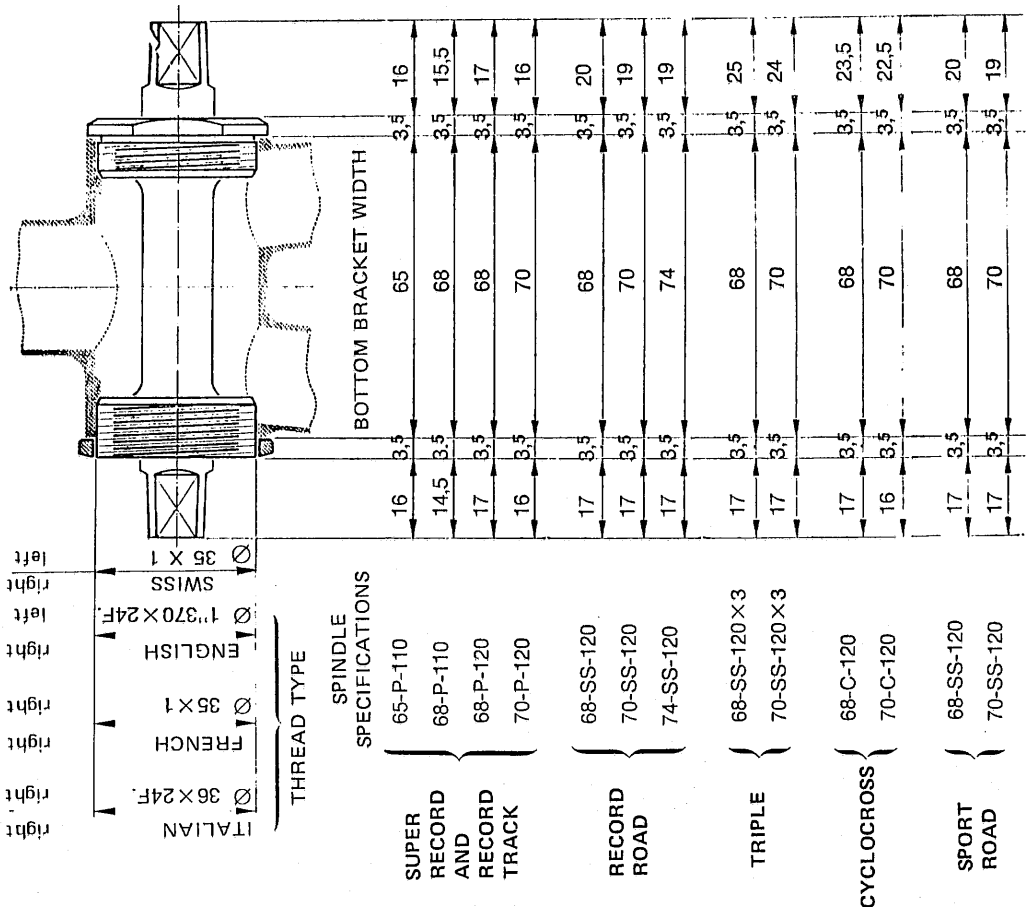

CUPS WITH A 0,5 mm. INCREASED THREAD AVAILABLE

Details of the bracket serial number (ex.: 65-P-110)

- The number (65) indicates the bracket width
- (P) indicates track
- (SS) indicate road
- chain line (see pages 51-53)

BRACKET SETS ORDERED WITHOUT SPECIFICATION WILL BE SUPPLIED AS FOLLOWS:

- Spindle — 68-SS-120 (or 68-P-120, 68-C-120)
- Thread — 1.370 x 24 F.

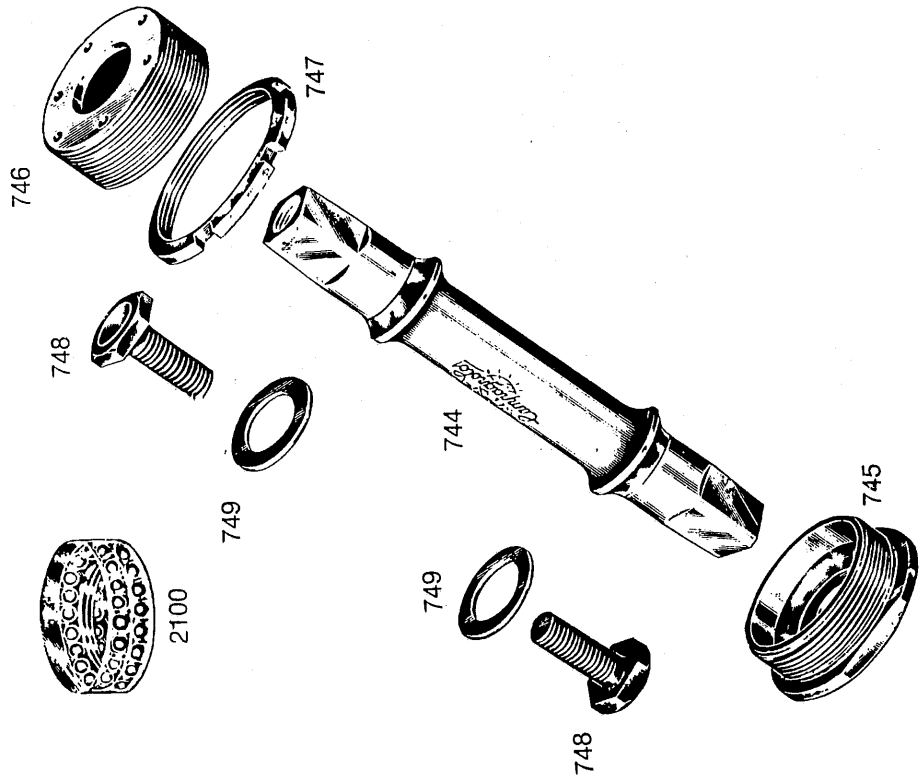

- 744 Copperless road spindle
- 745 Fixed cup *
- 746 Adjustable cup
- 747 Lockring 3,5 mm. standard size (available also in 4 and 4,5 mm.)
- 748 Fixing screw
- 749 Fixing washer
- 2100 Bottom bracket special ball races

* Swiss cup available on special order only

CAMPAGNOLO HEADSETS

4041 SUPER RECORD ROAD

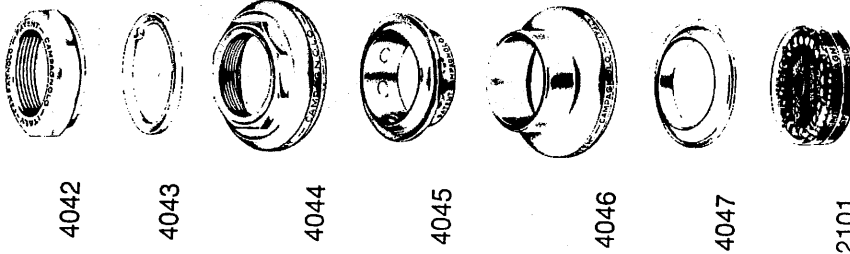

- 681 Locking nut
- 682 Locking washer
- 683 Screwed race
- 684 Top head race (0.5 mm larger gauge available)
- 685 Bottom head race (0.5 mm. larger gauge available)
- 686 Crown race (smaller diameter available)
- 687 Track screwed race
- 687/a Sport screwed race
- 688 Top head race (0.5 mm larger gauge available)

1039 RECORD ROAD

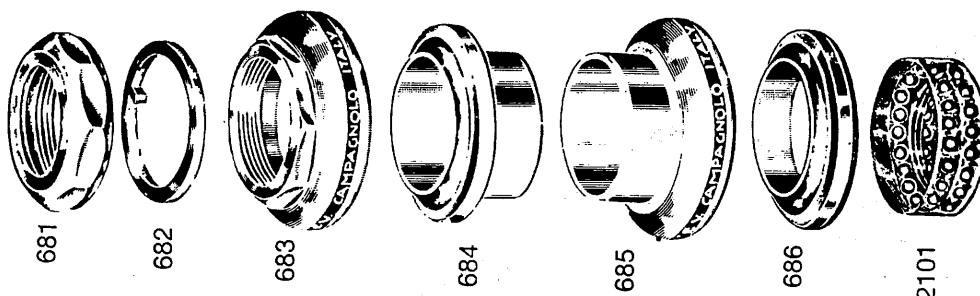

- 688/a Top head race (S) (0.5 mm larger gauge available)
- 689 Bottom head race (0.5 mm larger gauge available)
- 689/a Bottom head race (S) (0.5 mm larger gauge available)
- 690 Crown race (smaller diameter available)
- 690/a Crown race (S) (smaller diameter available)
- 693/1 Steerer
- 2101 Bearing set for road headset
- 2102 Bearing set for track headset
- 4042 Top (track or road) headset locknut (SR)

1040/a SPORT ROAD

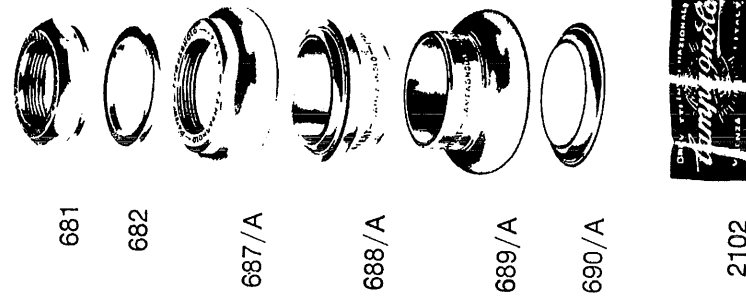

- 688/a Top head race (S) (0.5 mm larger gauge available)
- 689 Bottom head race (0.5 mm larger gauge available)
- 689/a Bottom head race (S) (0.5 mm larger gauge available)
- 690 Crown race (smaller diameter available)
- 690/a Crown race (S) (smaller diameter available)
- 693/1 Steerer
- 2101 Bearing set for road headset
- 2102 Bearing set for track headset
- 4042 Top (track or road) headset locknut (SR)

1040 RECORD TRACK

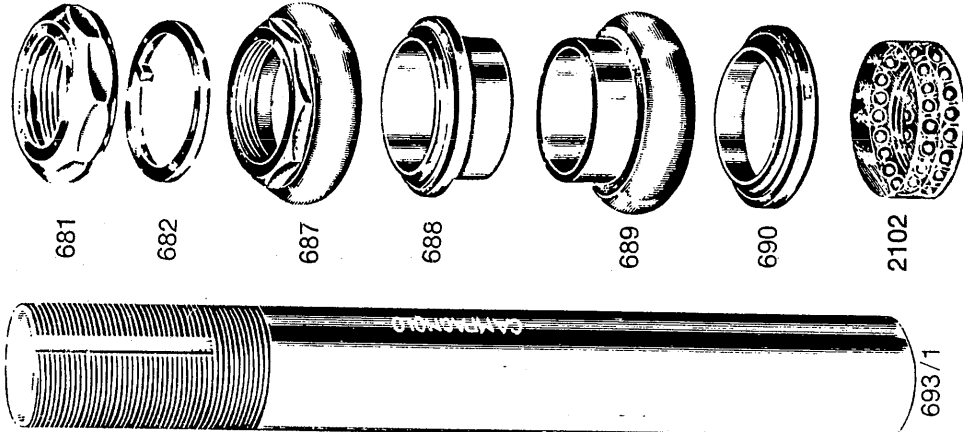

- 4141 SUPER RECORD TRACK
- 4042
- 4043
- 4142
- 4143
- 4144
- 4145
- 2102

HEADSETS ORDERED WITHOUT SPECIFICATION WILL BE SUPPLIED WITH \varnothing 1" x 24 T.P.I. THREAD

HEADSETS WITH \varnothing 25 x 1 AND \varnothing 25.4 x 24 F. THREADS AVAILABLE

CAMPAGNOLO HEADSETS ARE SUPPLIED COMPLETE WITH SPECIAL BALL RACES (\varnothing 3/16" FOR ROAD AND \varnothing 5/32" FOR TRACK)

STEERER AVAILABLE WITH THREAD \varnothing 25.4 x 24 F. AND WITH LENGTHS 160-180-200-220-250-270 mm.

1037 ROAD TYPE

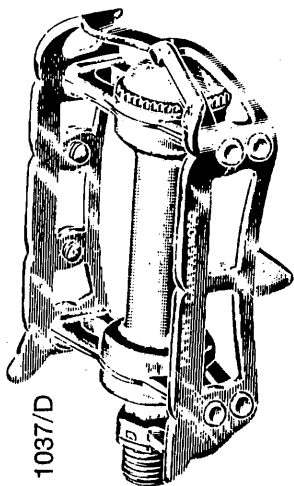

1037/D

1037/D Road right hand pedal

1037/S Road left hand pedal

1038 TRACK TYPE

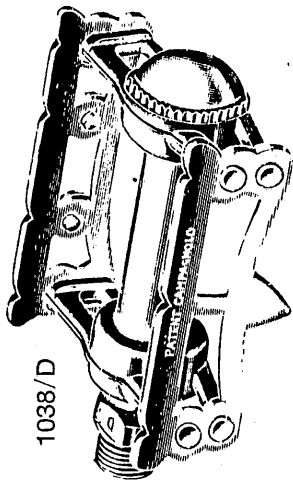

1038/D

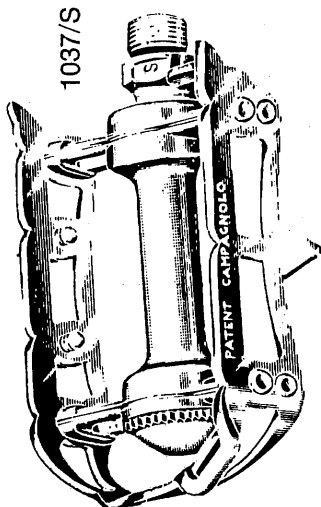

1037/S

1038/D Track right hand pedal

1038/S Track left hand pedal

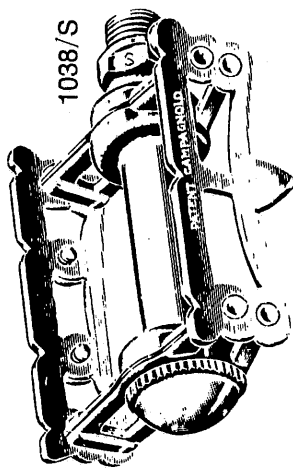

1038/S

SPARE PARTS

- * 669 Left hand pedal axle
- * 670 Right hand pedal axle
- 672 Inserted race
- 673 Pedal axle washer
- 674 Pedal axle cone
- 675 Pedal axle lock nut
- 676 Toe clip bolt
- 677 Toe clip washer
- 678 Inner dust cap
- 679 Pedal dust cap
- 2103 Pedal special ball races

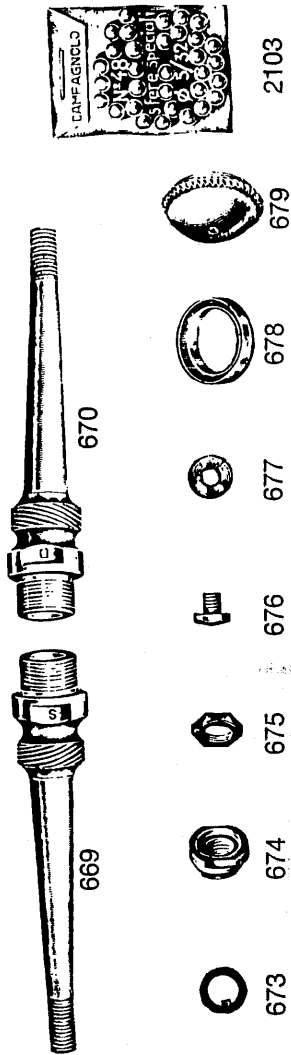

*UNLESS OTHERWISE REQUESTED, PEDALS WILL BE SUPPLIED WITH \varnothing 9/16" X 20F. SPINDLE
 PEDALS WITH \varnothing 14 X 1.25 (FRENCH) THREAD SPINDLES AVAILABLE

CAMPAGNOLO RECORD EXTRA LIGHT PEDALS

1037/a Road type

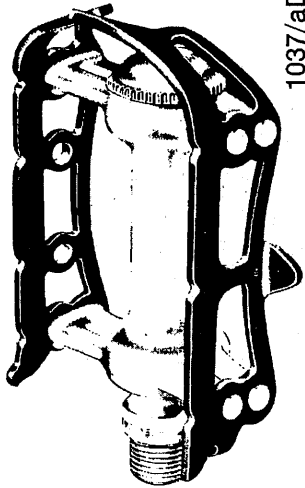

1037/aD Extra light road right hand pedal
1037/aS Extra light road left hand pedal

1037/aD

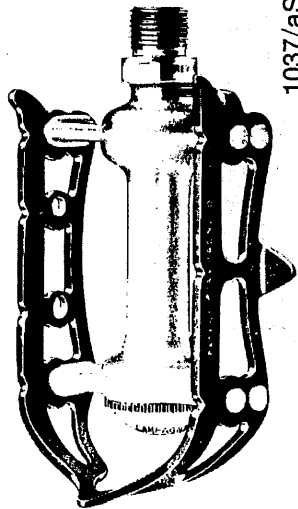

1037/aS

1038/aD Extra light track right hand pedal
1038/aS Extra light track left hand pedal

1038/a Track type

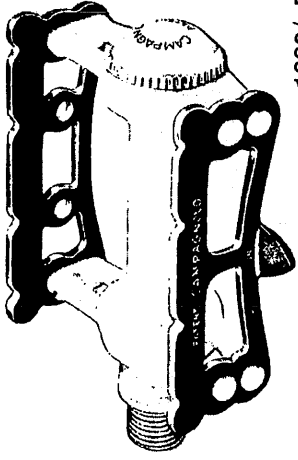

1038/aD

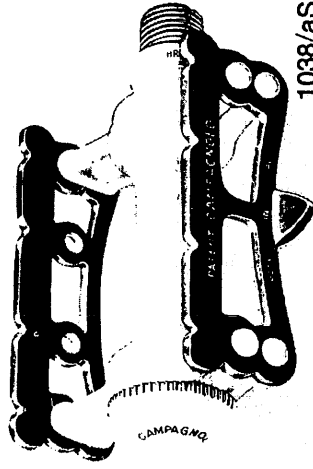

1038/aS



SUPER RECORD PEDAL PARTS



672



673



674



675



678



679/A



89



2103

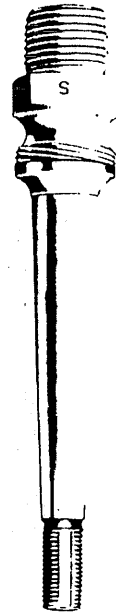

4024

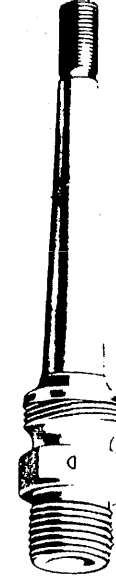

4025

- 89 Toe clip bolt
- 672 Inserted pedal race (All)
- 673 Pedal axle tapered washer (All)
- 674 Pedal axle cone (All)
- 675 Pedal axle lock nut (All)
- 677 Washer for 676, 124, 89
- 678 Inner dust cap (All Pedals)
- 679/A Pedal dust cap (SR, SL)

- 2103 Pedal bearings
- 4024 R.H. titanium pedal shaft (SR)
- 4025 L.H. titanium pedal shaft (SR)

- 2040 CAMPAGNOLO BRAKES AND CONTROL LEVERS
- 2040/1 CAMPAGNOLO SHORT-REACH BRAKES AND CONTROL LEVERS
- 4061 CAMPAGNOLO SUPER RECORD BRAKES AND CONTROL LEVERS
- 4061/1 CAMPAGNOLO SUPER RECORD SHORT-REACH BRAKES AND CONTROL LEVERS

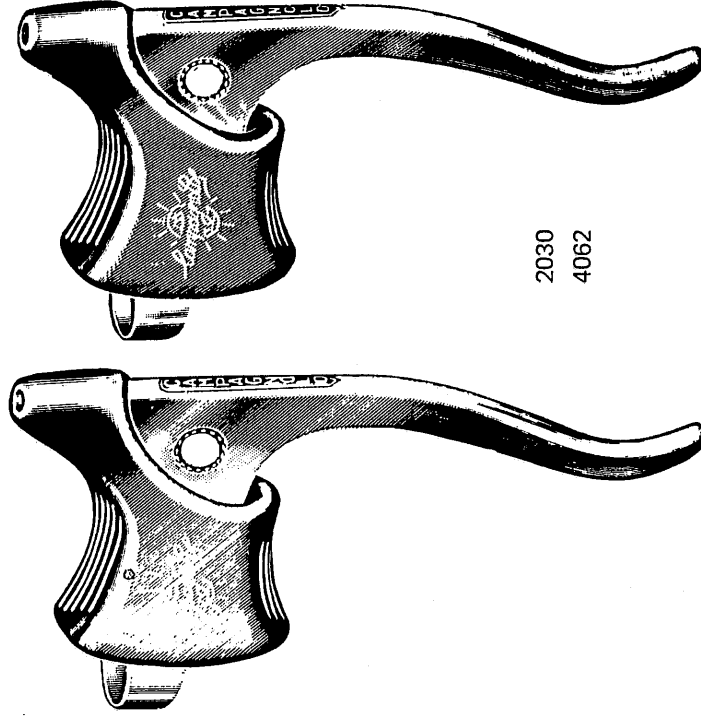

2030
4062

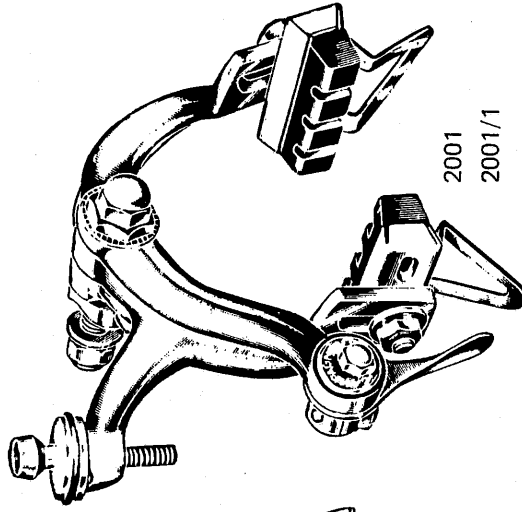

2001
2001/1

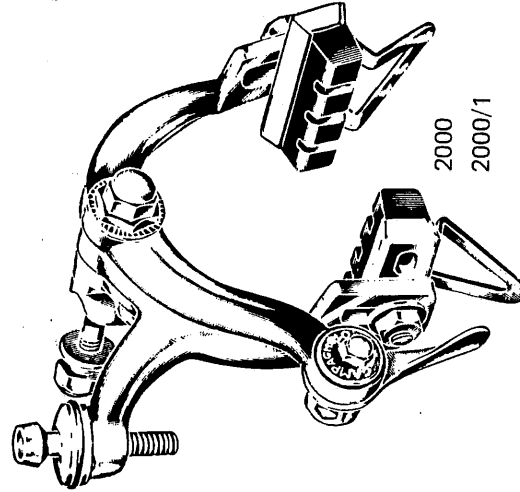
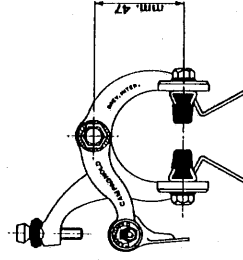

2000
2000/1

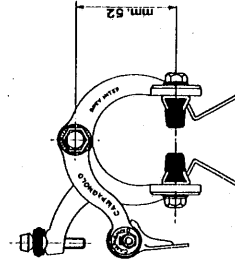

- 2000 Front caliper
- 2000/1 Front caliper (short-reach)
- 2001 Rear caliper
- 2001/1 Rear caliper (short-reach)
- 2030 Brake quick release lever
- 4062 Super Record "drilled" lever (see page 38)

IF REQUESTED, OUTER CASINGS AND CABLES ARE FURNISHED, INCREASED BY 6 cm (SEE NORMAL MEASURES ON PAGE 38)

CAMPAGNOLO RECORD BRAKES AND CONTROL SYSTEM SPARE PARTS

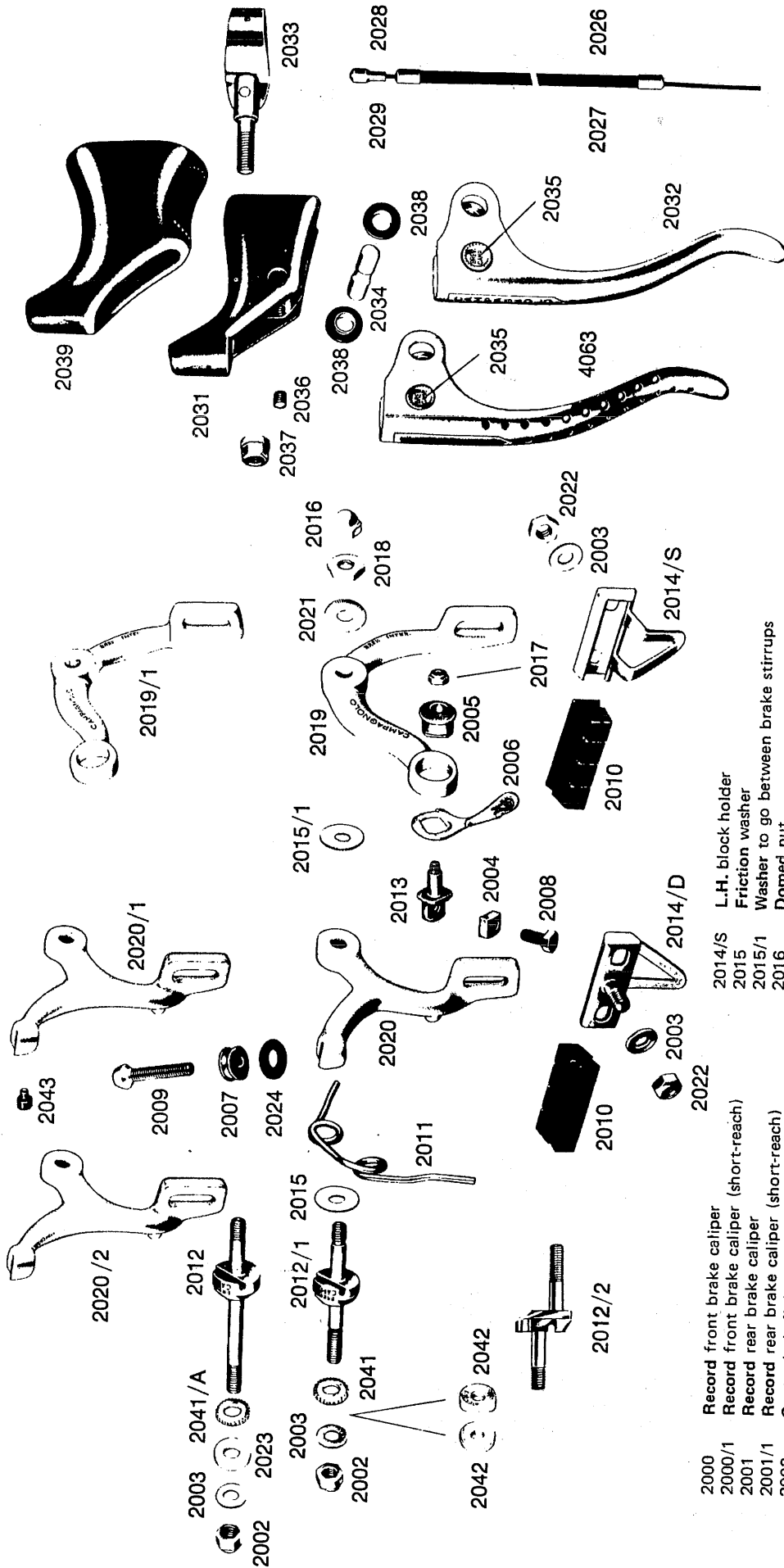

- 2000 Record front brake caliper
- 2000/1 Record front brake caliper (short-reach)
- 2001 Record rear brake caliper
- 2001/1 Record rear brake caliper (short-reach)
- 2002 Center bolt fixing nut
- 2003 Washer
- 2004 Clamp bolt washer
- 2005 Cam
- 2006 Quick release cam lever
- 2007 Adjusting nut
- 2008 Cable clamp bolt
- 2009 Adjusting screw
- 2010 Brake block
- 2011 Tension spring
- 2012 Front brake center bolt
- 2012/1 Rear brake center bolt
- 2012/2 Rear brake center bolt (6mm offset)
- 2013 Cable clamp
- 2014/D R.H. block holder
- 2014/S L.H. block holder
- 2015 Friction washer
- 2015/1 Washer to go between brake stirrups
- 2016 Domed nut
- 2017 Cam locking nut
- 2018 Locking nut
- 2019 R.H. stirrup
- 2019/1 R.H. caliper stirrup (short-reach)
- 2020 L.H. stirrup
- 2020/1 L.H. front caliper stirrup (short-reach)
- 2020/2 L.H. rear caliper stirrup (short-reach)
- 2021 Serrated washer
- 2022 Concave washer (front caliper)
- 2023 Adjusting rubber
- 2024 Special brake spanner (see page 49 tools)
- 2025 Front brake outer cable (56 cm)
- 2026 Rear brake outer cable (114 cm)
- 2027 Front inner cable (68 cm)
- 2028
- 2029
- 2030
- 2031 Rear inner cable (126 cm)
- 2032 Lever
- 2033 Brake lever clip
- 2034 Lever pivot pin
- 2035 Cable nipple holder
- 2036 Grub screw
- 2037 Clamp nut
- 2038 Lever bush
- 2039 Rubber lever hood
- 2040 Toothed washer
- 2041/A Front toothed washer for mounting caliper
- 2042 Concave washer for mounting rear caliper
- 2043 Rubber stop for short-reach caliper
- 4063 Super Record "drilled" lever

CAMPAGNOLO SEAT PINS AND PARTS

1044 FOR WIDE CRADLE SADDLES
WITH SHORT ADJUSTMENT

SPARE PARTS

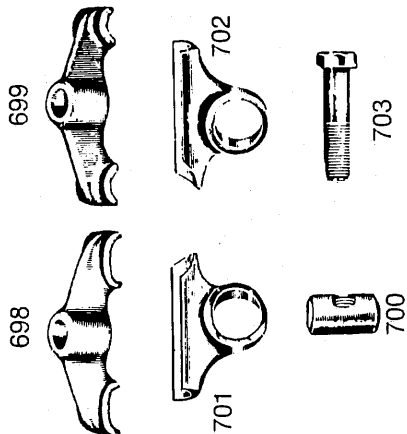
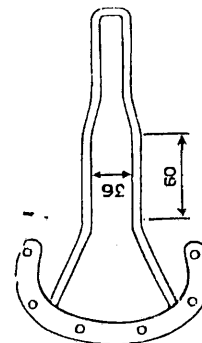
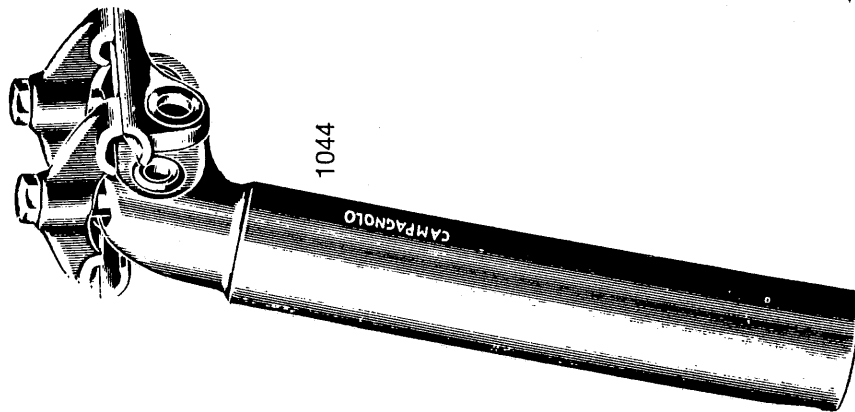

- 698 Front bracket
- 699 Rear bracket
- 700 Bolt nut
- 701 Left hand side support
- 702 Right hand side support
- 703 Fixing and adjusting bolt

1045 FOR NARROW CRADLE SADDLES
WITH LONG ADJUSTMENT

SPARE PARTS

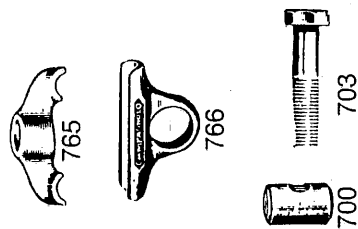
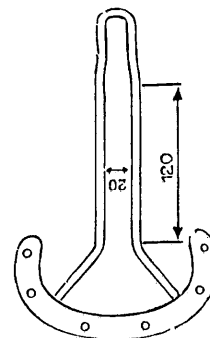
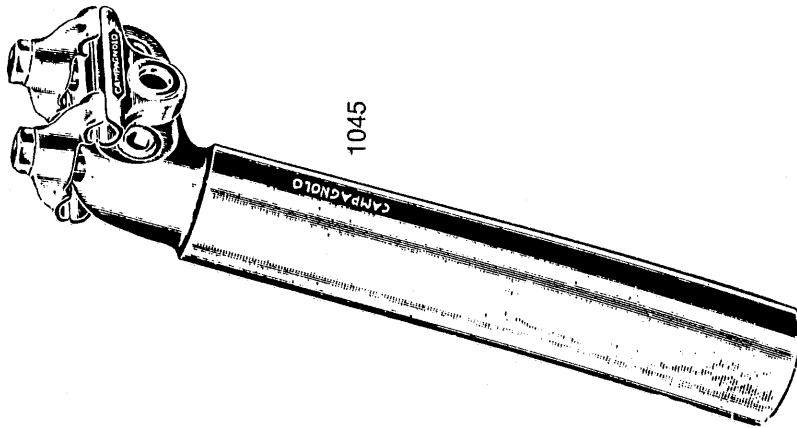

- 700 Bolt nut
- 703 Fixing and adjusting bolt
- 765 Front and rear clamp
- 766 Right and left hand support

WHEN ORDERING PLEASE SPECIFY:

— PIN DIAMETER AS PER ONE OF THE GIVEN SIZES: 25 - 25.8 - 26 - 26.2 - 26.4 - 26.6 - 26.8 - 27 - 27.2 - 27.4.

— LENGTH OF THE PIN - STANDARD (180 mm) — SHORT (130 mm)

CAMPAGNOLO SEAT PINS AND PARTS

SUPERLIGHT CAMPAGNOLO RECORD SEAT PIN FOR WIDE CRADLE SADDLES

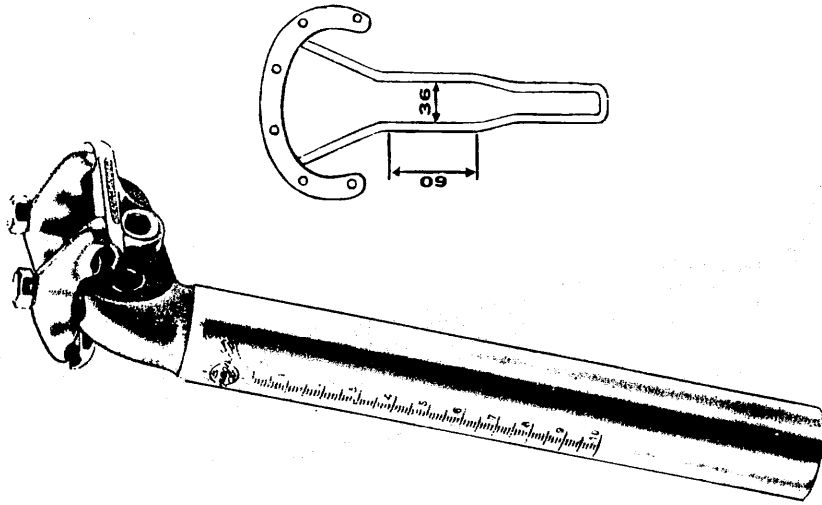

1044/a

SUPERLIGHT CAMPAGNOLO RECORD SEAT PIN FOR NARROW CRADLE SADDLES

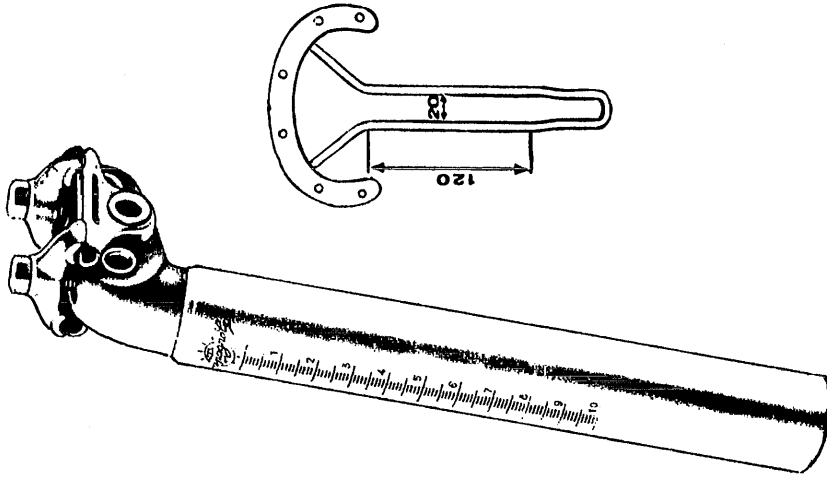

1045/a

CAMPAGNOLO SUPER RECORD SEAT PIN (AVAILABLE IN WIDE CRADLE ONLY)

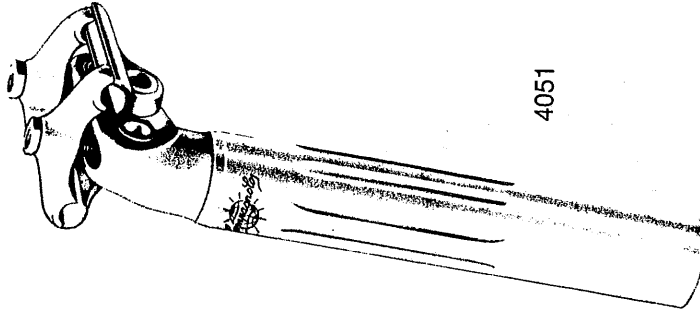

4051

SUPER RECORD SEAT PIN PARTS



4054



4055



4056



4052

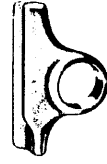

4053



4057

- 4052
- 4053
- 4054
- 4055
- 4056
- 4057

- L.H. seat support for 4051 (SR)
- R.H. seat support for 4051 (SR)
- Rear bracket for 4051 (SR)
- Front bracket for 4051 (SR)
- Fixing and adjusting bolt for 4051 (SR)
- Nut for 4056 (SR)

NOTE:
4051 available in 147mm length only.

1044 a Superlight Campagnolo RECORD seat pin for wide cradle saddles with short adjustment
1045 a Superlight Campagnolo RECORD seat pin for narrow cradle saddles with long adjustment

When ordering please specify:
— pin diameter as per one of the given sizes:
25 - 25.8 - 26 - 26.2 - 26.4 - 26.6 - 26.8 - 27 - 27.2 - 27.4
— length of the pin: standard (130 mm) - long (180 mm)

CAMPAGNOLO OUTER AND INNER CABLES

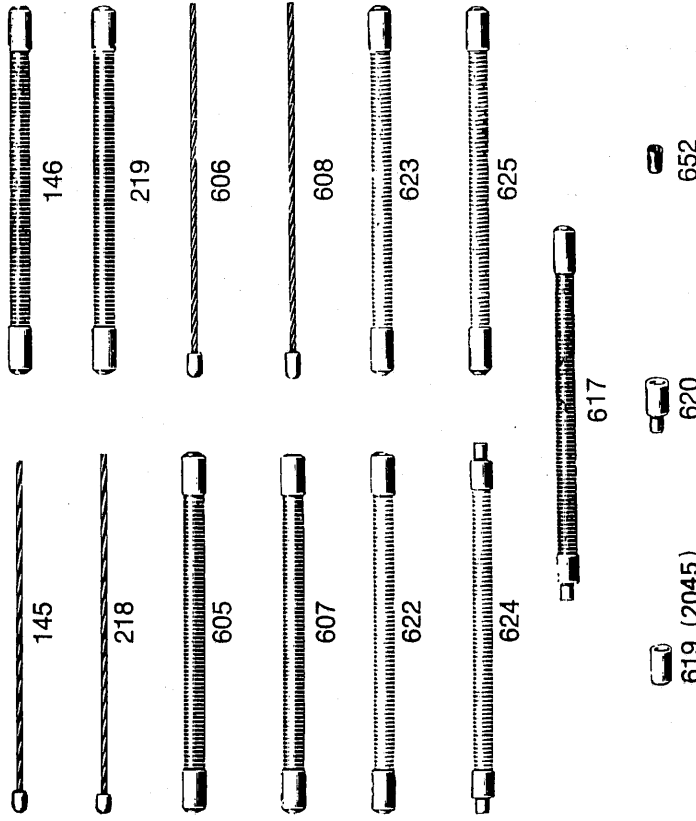

- 145 Rear derailleur cable to handlebar control (197 cm.)
- 146 Rear derailleur outer casing to handlebar control (185 cm.)
- 218 Front changer cable to handlebar control (150 cm.)
- 219 Front changer outer casing to handlebar control (140 cm.)
- 605 Gear outer casing (105 cm.)
- 606 Gear cable to frame control (118 cm.)
- 607 Down tube front outer casing (59 cm.)
- 608 Front changer cable to frame control (70 cm.)
- 617 Stainless cable casing to fit 621 (21 cm)
- 619 Outer casing ferrule
- 620 Spindled ferrule
- 622 Rear derailleur steel outer casing (21 cm.)
- 623 Front changer steel outer casing (15.5 cm.)
- 624 Chainstay outer casing (10 cm.)
- 625 Steel outer casing from handlebar control to 629 (75 cm)
- 652 Safety cable
- 711 Gear vipla outer casing (23 cm.)
- 2045 Brake cable casing end-protector

CAMPAGNOLO CLIPS

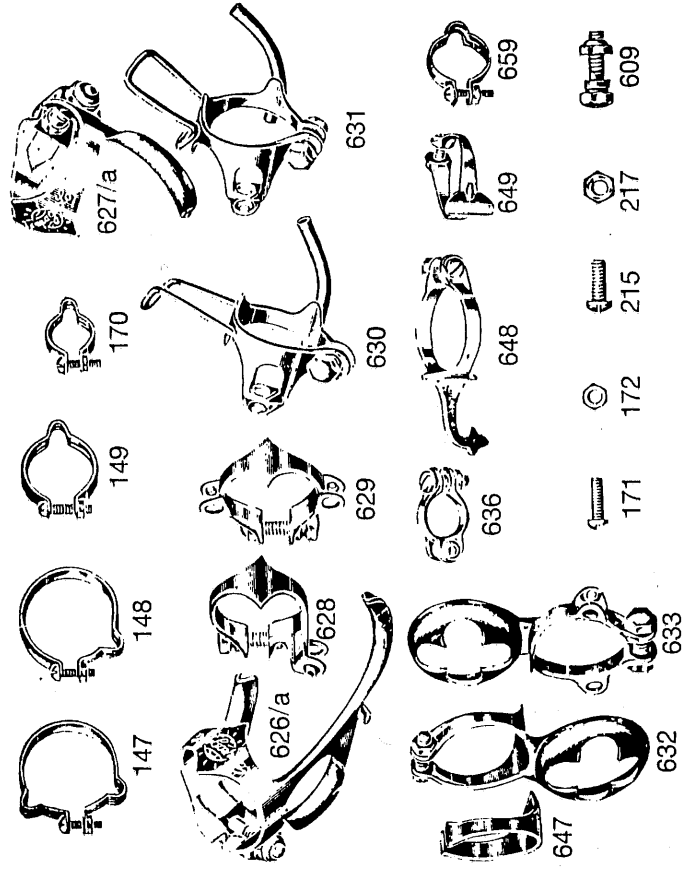

- 147 Twin outer cable clip (28 mm. Ø)
- 148 Outer cable clip (28 mm. Ø)
- 149 Outer cable clip (22 mm. Ø)
- 170 Outer cable clip (13 mm. Ø)
- 171 Clip bolt
- 172 Nut for bolt 171
- 215 Cage spanner bolt
- 217 Cage spacer bolt nut
- 608 Clip bolt and nut
- 609 Double stop clip for down tube controls
- 626/a Down tube tunnel R_L/H for gear
- 627/a Front changer clip
- 628 Double stop cable clip for handlebar control
- 629 Clip-on-tunnel and stop with pump holder D/T
- 630 Clip-on-tunnel and stop with pump holder
- 631 Pump holder
- 632 Clip with pump holder for 10-speed handlebar stops
- 633 Stop clip on chainstay for rear derailleur
- 647 Adaptor shim when fitting 632 to down tube
- 648 Pump peg holder
- 649 Brake cable clip
- 659 Outer cable clip (15 mm. Ø)

CAMPAGNOLO SPECIAL BINDER BOLTS

1220 CLIP WITH QUICK-RELEASE

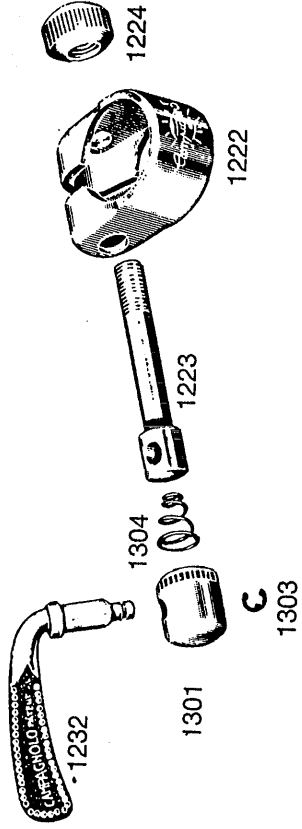

- 1222 Clip body (please specify body diameter)
- 1223 Spindle
- 1224 Adjusting nut
- 1232 Lever
- 1301 Lever block
- 1303 Circlip
- 1304 Tension spring

1230 CLIP WITH INCORPORATED QUICK-RELEASE

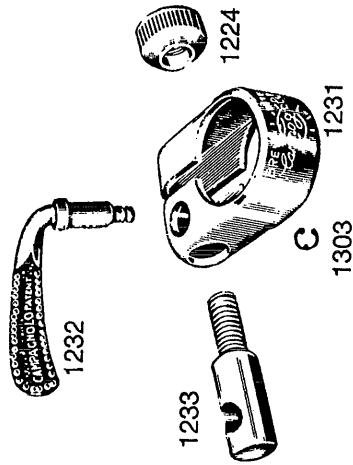

- 1224 Adjusting nut
- 1231 Clip body (please specify body diameter)
- 1232 Lever
- 1233 Spindle
- 1303 Circlip

1240 SPECIAL QUICK-RELEASE BOLT

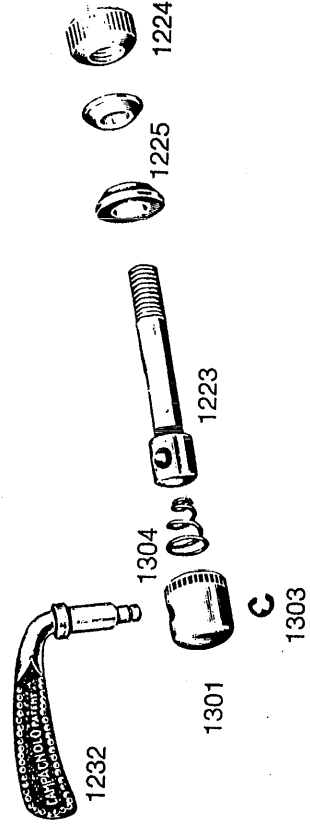

- 1223 Spindle
- 1224 Adjusting nut
- 1225 Spacing washers
- 1232 Lever
- 1301 Lever block
- 1303 Circlip
- 1304 Tension spring

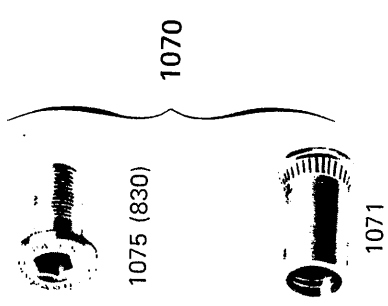

1075 (830)

1070

1071

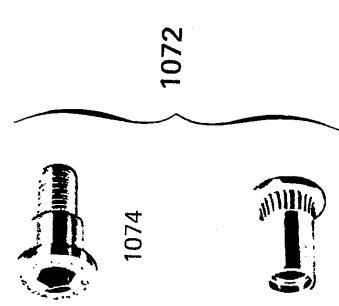

1074

1072

1073

- 830 Bolt for fixing seat pin to frame (. . . 10)
- 1070 Bolt and nut for fixing seat pin to frame (. . . 10)
- 1071 Nut for fixing seat pin to frame (. . . 10)
- 1072 Bolt and nut for fixing seat pin to frame (. . . 8)
- 1073 Nut for fixing seat pin to frame (. . . 8)
- 1074 Bolt for fixing seat pin to frame (. . . 8)
- 1075 Bolt for nut 1071 (Ø 10)

WHEN ORDERING PLEASE ALWAYS SPECIFY THE DESIRED DIAMETER OF CLAMP

1010 RECORD SET

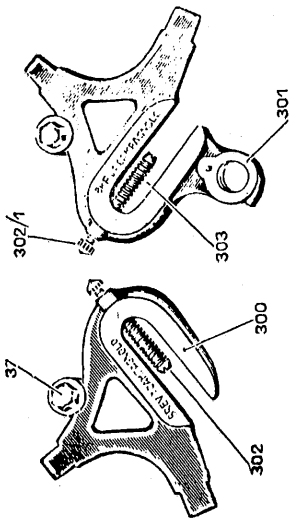

- 2 Front fork ends
- 37 Screw and washer
- 300 Left hand rear end
- 301 Right hand rear end
- 302 Adjusting bolt
- 302/1 Nut for bolt 302
- 303 Adjusting bolt spring

1010 1 SPORT SET



- 310 Left hand rear end
- 311 Right hand rear end
- 312 Front fork ends

1010/a REAR AND FRONT FORK ENDS WITHOUT EYELETS

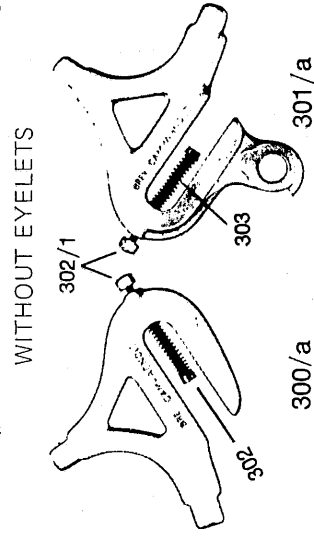

1053 TRACK SET

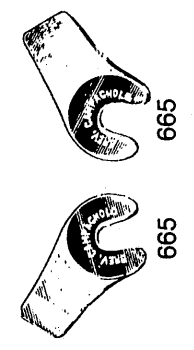
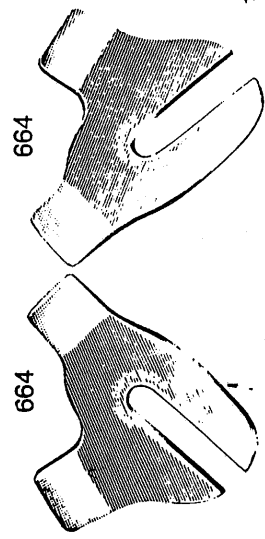

- 664 Rear fork ends
- 665 Front fork ends

1060 RACING SET

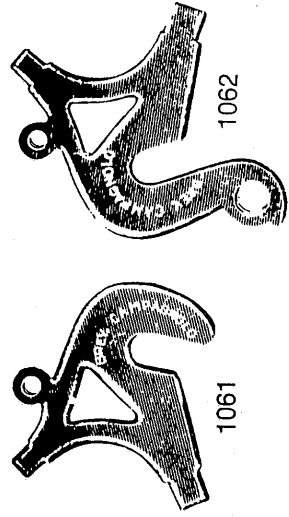

- 1061 Left hand rear end
- 1062 Right hand rear end
- 1063 Front fork ends

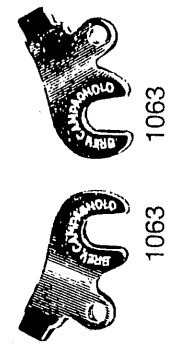

CAMPAGNOLO PUMP ENDS, TRACK SPROCKETS AND GREASE

PUMP ENDS

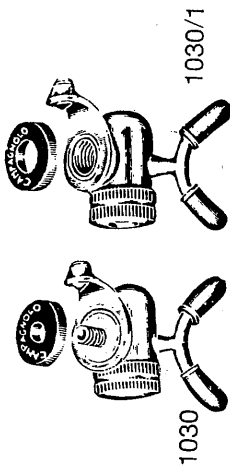

1030 1030/1

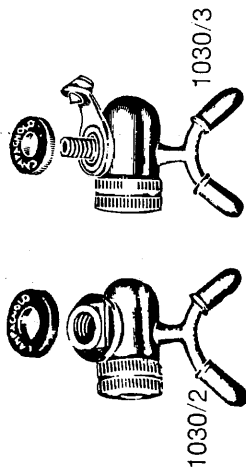

1030/2 1030/3

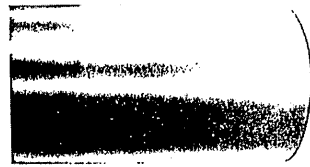

SUNDRIES

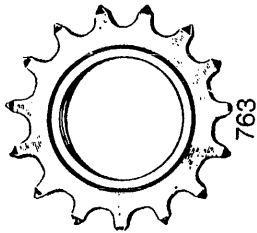

763

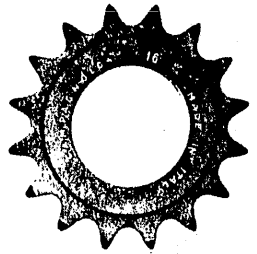

763/a

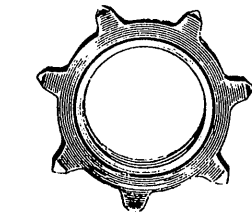

764

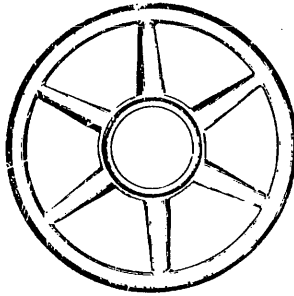

55

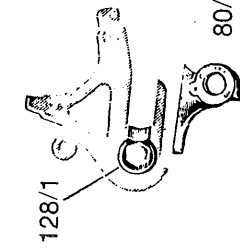

128/1 80/1



3346

SPARE PARTS

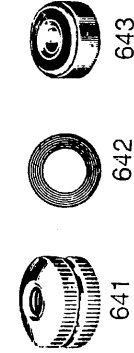

640



641



642



643



644



645



646



647

- 640 Rubber cap
- 641 Milled nut
- 642 Rubber washer
- 643 Rubber washer for tubular valves
- 644 Rubber washer for pump connector 1030
- 645 Connecting screw
- 646 Rubber washer for pump connectors 1030 1 and 1030 2
- 647 Rubber washer for pump connector 1030 3
- 1030 Pump connector for British pumps complete with 7 32" or 7 x 1 locking screw
- 1030 1 Pump connector for Italian pumps with 9 x 1.25 locking screw
- 1030 2 Pump connector for Italian Silca Impero pumps with 9 x 1.25 squared boss
- 1030 3 Pump connector for French pumps with 5 x 1 or 7 x 1 locking screw
- 55 Spoke disc (specify if for 4 or 5 sprockets)
- 80 1 Gear fixing plate
- 128 1 Rear fork end bolt
- 651 Freewheel spacer (1 - 1.5 - 2 mm. thick)
- 763 Standard sprocket for 1 1/2" x 1 1/8" 3 mm. chain. (Sprockets with 12 - 13 - 14 - 15 - 16 teeth available)
- 764 Racing chain sprocket for 1" x 3/16 (4.6 mm.) chain. (Sprocket with 6 - 7 - 8 or for 1" x 1 1/8" chain available)
- 763 a Superlight standard sprocket for 1 1/2" x 1 1/8" 3 mm. chain. (Sprockets with 12 - 13 - 14 - 15 - 16 teeth available).
- 3345 Adaptor ensemble with ring
- 3346 Adaptor ensemble with square boss

SPECIAL GREASE

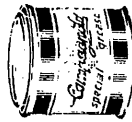

3385 100 grams



3386 500 grams



3387 1 kilogram

3380 COMPLETE CAMPAGNOLO TOOL CASE

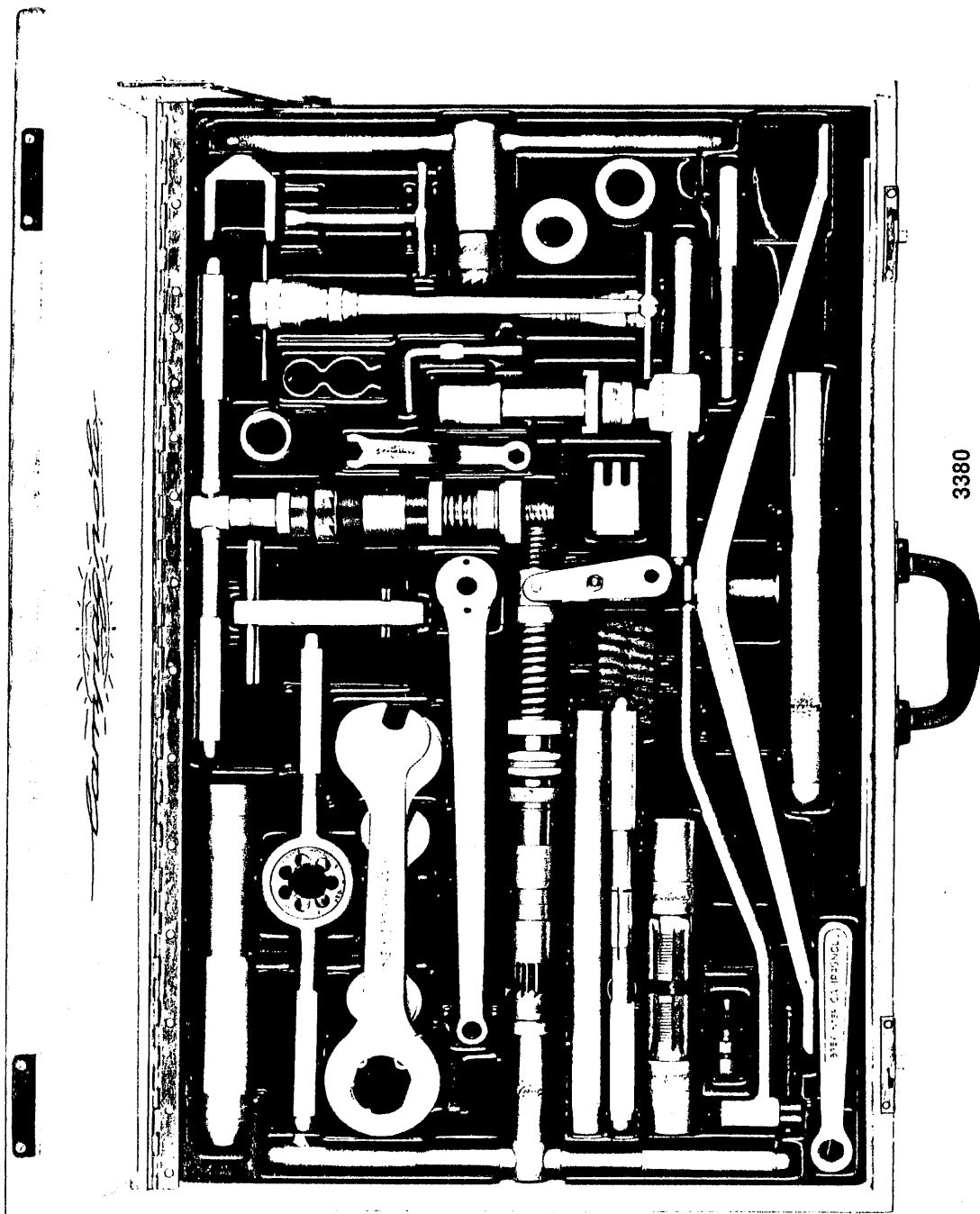

3380

3381 PARTIAL CAMPAGNOLO TOOL CASE

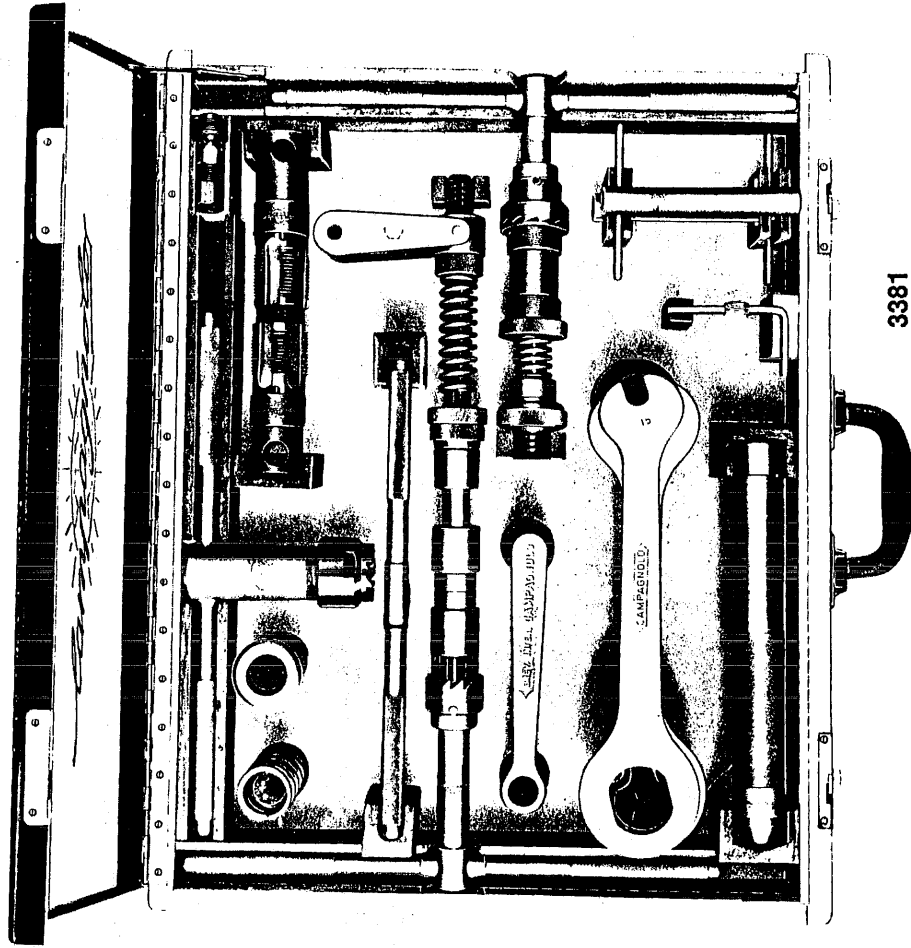

3381

SPECIAL CAMPAGNOLO TOOLS (FROM 3380 AND 3381)

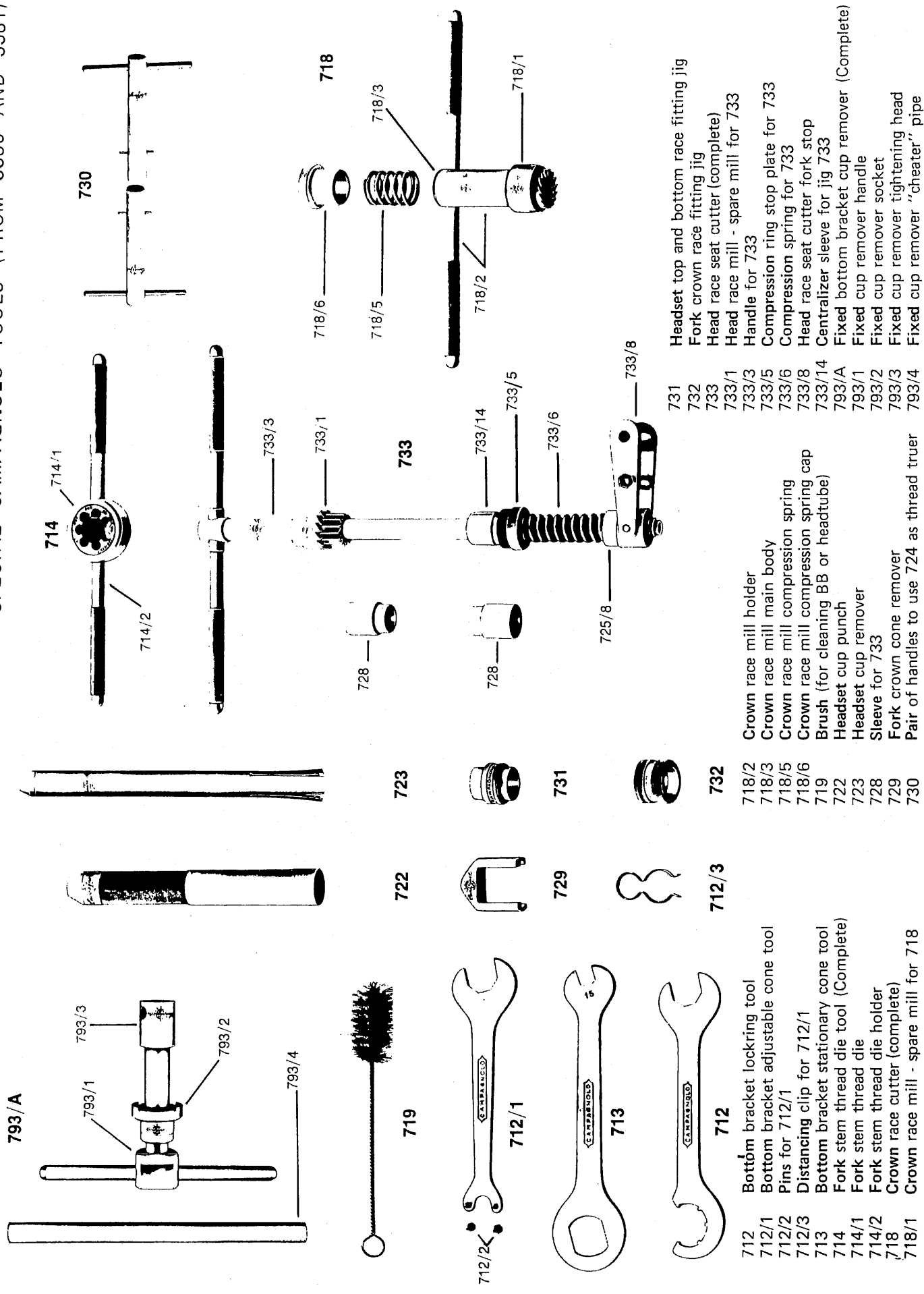

793/A

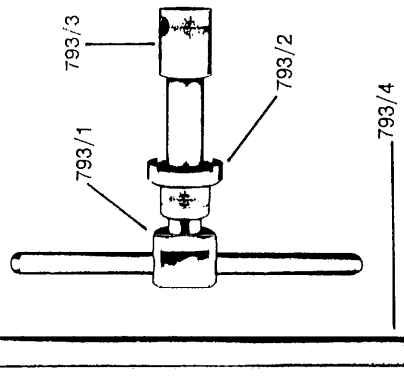

793/4

719



712/2



712/1

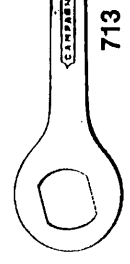

713



712

- 712 Bottom bracket locking tool
- 712/1 Bottom bracket adjustable cone tool
- 712/2 Pins for 712/1
- 712/3 Distancing clip for 712/1
- 713 Bottom bracket stationary cone tool
- 714 Fork stem thread die tool (Complete)
- 714/1 Fork stem thread die
- 714/2 Fork stem thread die holder
- 718 Crown race cutter (complete)
- 718/1 Crown race mill - spare mill for 718

722



723

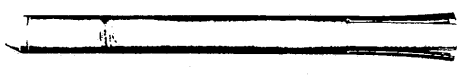

729



731



712/3



732

- 718/2 Crown race mill holder
- 718/3 Crown race mill main body
- 718/5 Crown race mill compression spring
- 718/6 Crown race mill compression spring cap
- 719 Brush (for cleaning BB or headtube)
- 722 Headset cup punch
- 723 Headset cup remover
- 728 Fork crown cone remover
- 729 Pair of handles to use 724 as thread truer
- 730



728



728

725/8



733/8



733/1

733



733/14

733/6

- 731 Crown race mill holder
- 732 Crown race mill main body
- 733 Crown race mill compression spring
- 733/1 Crown race mill compression spring cap
- 733/14 Brush (for cleaning BB or headtube)
- 733/A Headset cup punch
- 793/1 Headset cup remover
- 793/2 Fork crown cone remover
- 793/3 Pair of handles to use 724 as thread truer
- 793/4



718



718/5

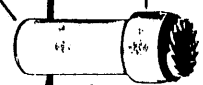

718/3

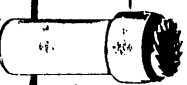

718/6



718/2



718/1

- 731 Headset top and bottom race fitting jig
- 732 Fork crown race fitting jig
- 733 Head race seat cutter (complete)
- 733/1 Head race mill - spare mill for 733
- 733/3 Handle for 733
- 733/5 Compression ring stop plate for 733
- 733/6 Compression spring for 733
- 733/8 Head race seat cutter fork stop
- 733/14 Centralizer sleeve for jig 733
- 793/A Fixed bottom bracket cup remover (Complete)
- 793/1 Fixed cup remover handle
- 793/2 Fixed cup remover socket
- 793/3 Fixed cup remover tightening head
- 793/4 Fixed cup remover "cheater" pipe

SPECIAL TOOLS (Continued)

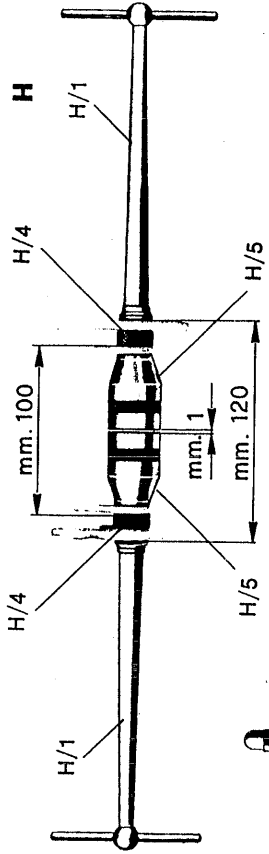

- 721 Bottom bracket double tap tool (Complete)
- 721/1 L.H. die-holding ring for 721
- 721/2 R.H. die-holding ring for 721
- 721/3 Die-holding bottom locking
- 721/5 Bottom bracket tap - spare tap for 721
- 724/1 Internal thread guide for 725
- 724/2 External thread guide for 725

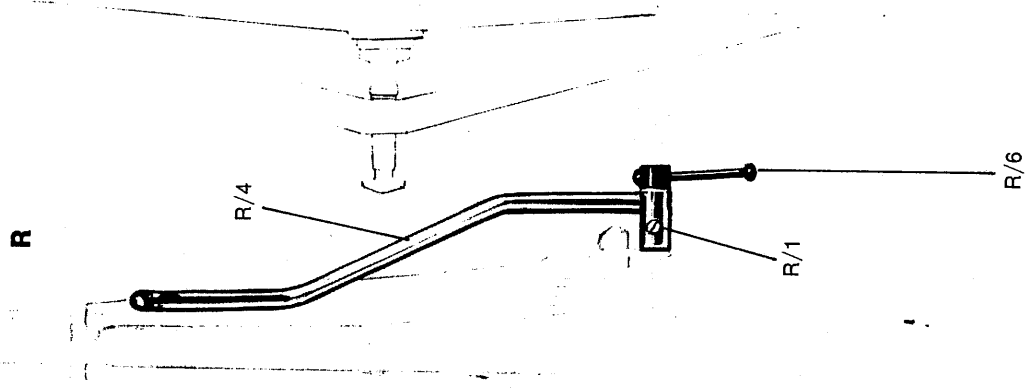
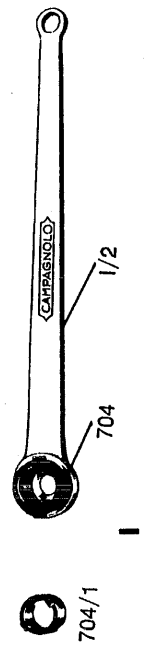
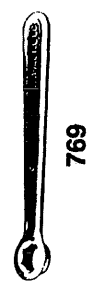
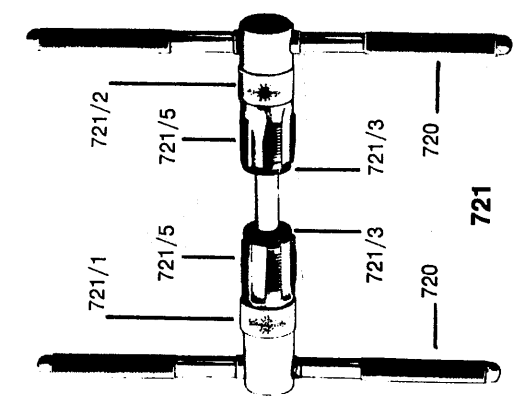
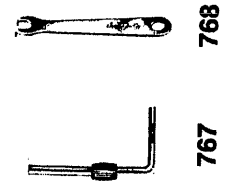
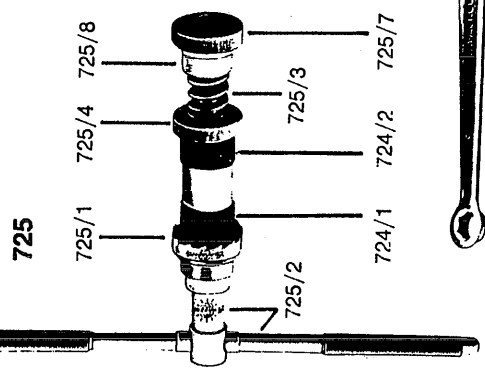
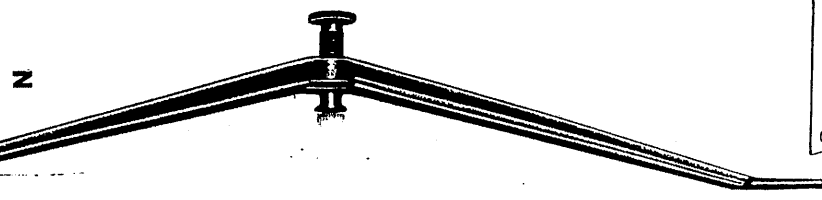

- 143/2 "T" wrench
- 704 Socket for freewheel removing tool
- 704/1 Reducing socket for 704 to fit 13T freewheel
- 705 Pedal tap R.H. (9/16" dia. x 20 TPI)
- 706 Pedal tap L.H. (9/16" dia. x 20 TPI)
- 707 Gear hanger tap (10 mm dia. x 26 TPI)
- 708 Madguard eye tap (5 mm dia. x 0.8 TPI)
- 709 Rear dropout adjuster tap (3 mm dia. x 0.5 TPI)
- 710 Pedal cap and locknut wrench
- 720 Handle for 721



- 725 Bottom bracket face cutter (complete)
- 725/1 Bottom bracket face mill - spare mill for 725
- 725/2 Handle for 725
- 725/3 Compression spring for 725
- 725/4 Compression spring top plate
- 725/7 Compression spring swivel grip
- 725/8 Compression spring swivel ring for 725, 733
- 736 Saddle-Line alignment tool
- 736/1 Main vertical body for tool 736
- 736/12 Vertical height body sleeve
- 736/14 Vertical height clamp
- 736/15 Vertical height clamp screw
- 736/16 Leveling rod
- 736/19 Leveling rod clamp bolt
- 736/20 Leveling rod clamp handle
- 736/22 Leveling rod front alignment pin
- 736/23 Leveling rod front alignment set screw
- 736/24 Vertical height clamp nut

SPECIAL TOOLS (Continued)



771

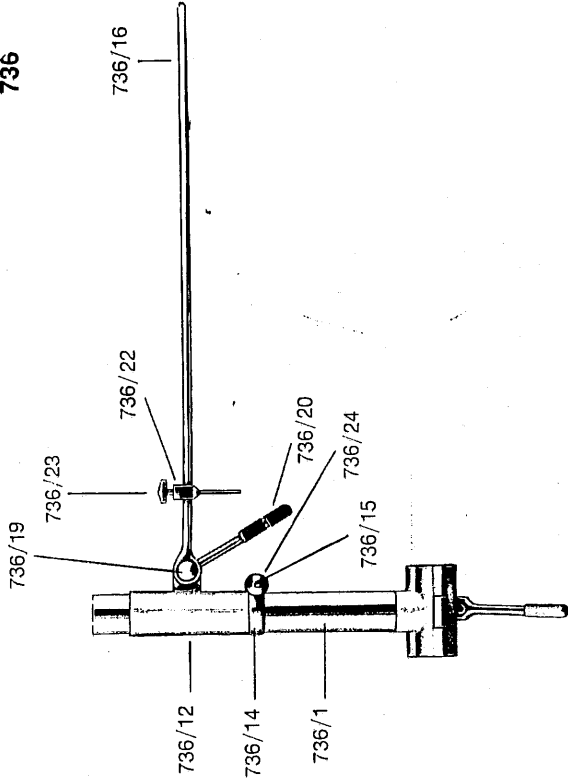

736

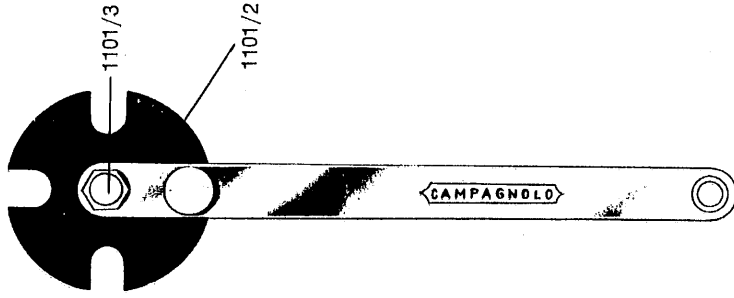

1101/1

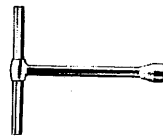

143/2

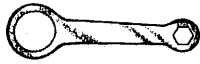

710



2025



705



706



707



708



709

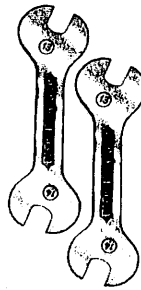

Q

- 767 L-Shaped chainwheel cap allen key
- 768 Chainwheel fastening screw spanner
- 769 Cotterless spindle end bolt spanner
- 770 Cotterless crank extractor
- 771 Saddle spanner
- 1101 Pedal spanner
- 1101/1 Handle for pedal spanner
- 1101/2 Main plate for pedal spanner
- 1101/3 Center fixing bolt for pedal spanner
- 2025 Special brake spanner

- N Wheel dish tool
- P Axle holding tool for 9 and 10 mm dia.
- Q Cone wrenches 13/14 or 15/16
- R Backstay tool
- R/1 Set-Screw for R tool
- R/4 Main arm for R tool
- R/6 Tightening handle for R tool

- G Straight edge
- H Backstay alignment tool (pair)
- H/1 Handle for H tool
- H/4 Fork locking for H tool
- H/5 Head for H tool
- I Freewheel removing tool complete
- I/2 Handle for I tool

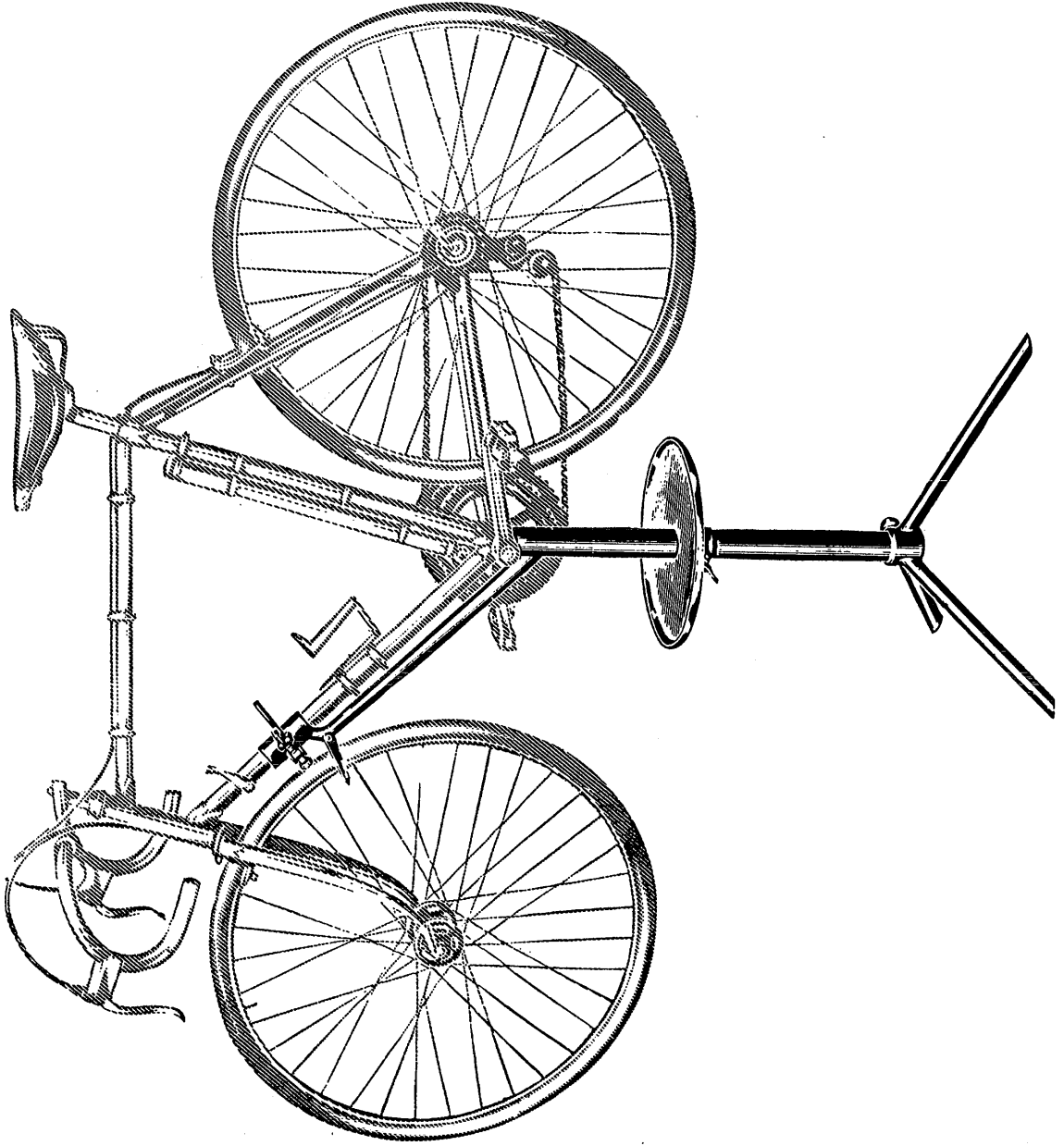

CAMPAGNOLO ROAD CHAIN LINE

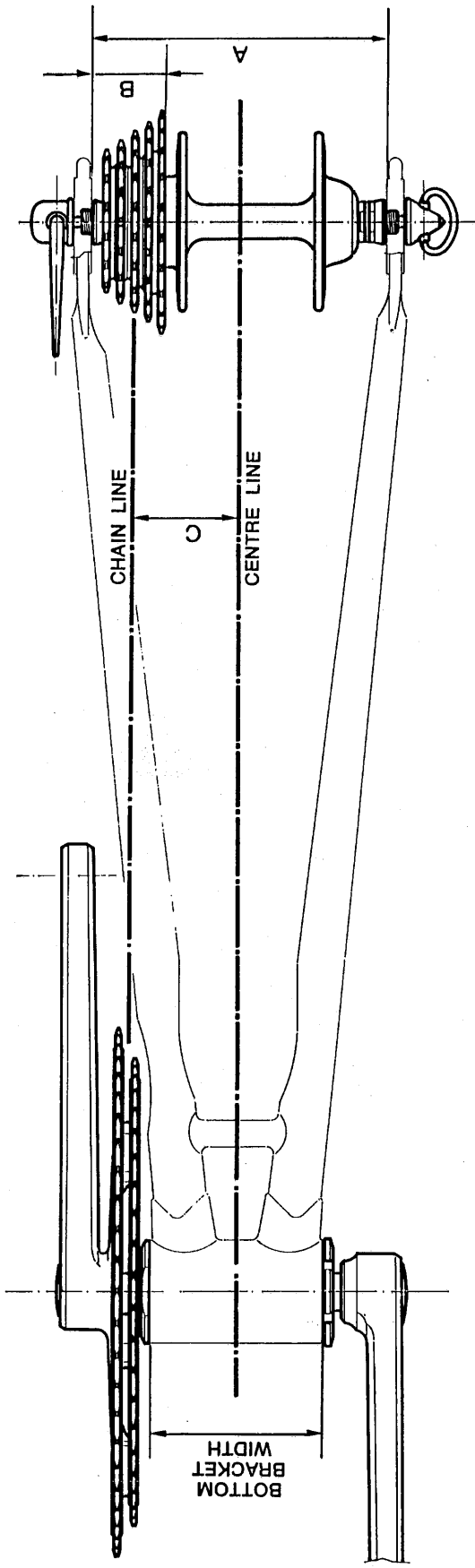

| BOTTOM BRACKET WIDTH | REAR HUB WIDTH « A » | FREEWHEEL WIDTH « B » | CHAIN LINE « C » |
|----------------------|----------------------|-----------------------|------------------|
| 68 | 120 | 29 | 43,5 |
| 70 | 120 | 29 | 43,5 |
| 74 | 120 | 29 | 43,5 |

CAMPAGNOLO TRACK CHAIN LINE

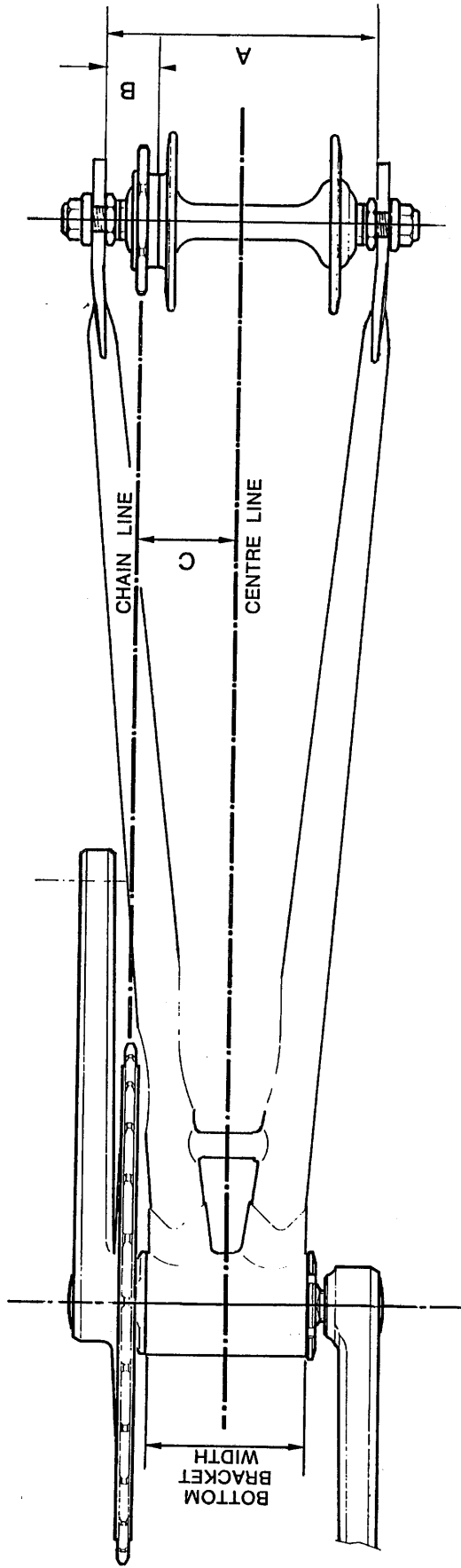

| BOTTOM BRACKET WIDTH | REAR HUB WIDTH « A » | SPROCKET WIDTH « B » | CHAIN LINE « C » |
|----------------------|----------------------|----------------------|------------------|
| 65 | 110 | 21.5 | 40 |
| 68 | 110 | 21.5 | 40 |
| 68 | 120 | 24 | 42,5 |
| 70 | 120 | 24 | 42,5 |

CAMPAGNOLO TANDEM CHAIN LINE

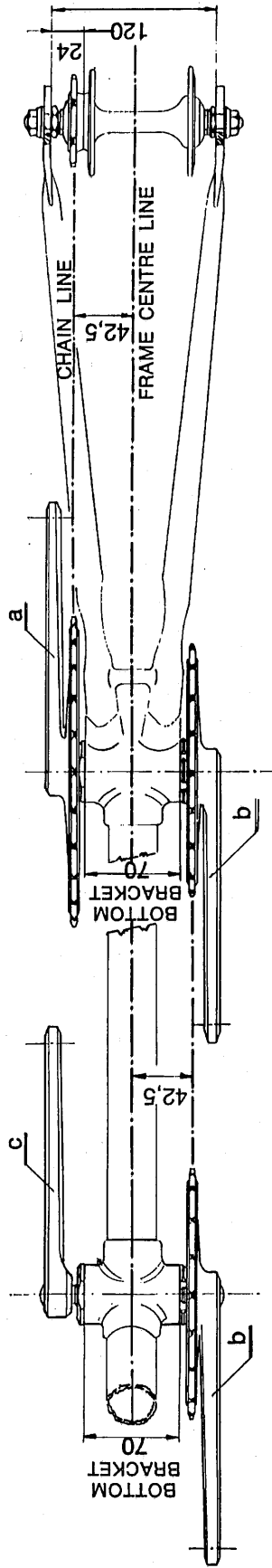

| | |
|----------|--|
| a | TRACK (OR ROAD) RIGHT HAND STANDARD CRANK |
| b | TRACK (OR ROAD) RIGHT HAND CRANK WITH LEFT HAND THREAD |
| c | TRACK (OR ROAD) LEFT HAND CRANK WITH RIGHT HAND THREAD |

GEAR TABLE 27" WHEELS

GEAR TABLE 27" WHEELS

| | 36 | 38 | 40 | 42 | 44 | 45 | 46 | 47 | 48 | 49 | 50 | 51 | 52 | 54 |
|----|------|------|------|------|------|-------|-------|-------|-------|-------|-------|-------|-------|-------|
| 12 | 81.0 | 85.5 | 90.0 | 94.5 | 99.0 | 101.2 | 103.5 | 105.0 | 108.0 | 110.3 | 112.5 | 114.7 | 117.0 | 121.5 |
| 13 | 74.7 | 78.9 | 83.1 | 87.2 | 91.4 | 93.4 | 95.5 | 97.6 | 99.7 | 101.8 | 103.8 | 105.9 | 108.0 | 112.1 |
| 14 | 69.4 | 73.3 | 77.1 | 81.0 | 84.8 | 86.7 | 88.7 | 90.6 | 92.6 | 94.5 | 96.4 | 98.3 | 100.3 | 104.1 |
| 15 | 64.8 | 68.4 | 72.0 | 75.6 | 79.2 | 80.9 | 82.8 | 84.6 | 86.4 | 88.2 | 90.0 | 91.8 | 93.6 | 97.2 |
| 16 | 60.8 | 64.1 | 67.5 | 70.9 | 74.2 | 76.0 | 77.6 | 79.3 | 81.0 | 82.7 | 84.4 | 86.1 | 87.7 | 91.1 |
| 17 | 57.2 | 60.3 | 63.5 | 66.7 | 69.9 | 71.5 | 73.0 | 74.6 | 76.2 | 77.8 | 79.4 | 81.0 | 82.6 | 85.7 |
| 18 | 54.0 | 57.0 | 60.0 | 63.0 | 66.0 | 67.5 | 69.0 | 70.5 | 72.0 | 73.5 | 75.0 | 76.5 | 78.0 | 81.0 |
| 19 | 51.2 | 54.0 | 56.8 | 59.7 | 62.5 | 64.0 | 65.4 | 66.8 | 68.2 | 69.6 | 71.0 | 72.5 | 73.9 | 76.7 |
| 20 | 48.6 | 51.3 | 54.0 | 56.7 | 59.4 | 60.8 | 62.1 | 63.4 | 64.8 | 66.1 | 67.5 | 68.8 | 70.2 | 72.9 |
| 21 | 46.3 | 48.9 | 51.4 | 54.0 | 56.6 | 57.9 | 59.1 | 60.4 | 61.7 | 63.0 | 64.3 | 65.5 | 66.8 | 69.4 |
| 22 | 44.2 | 46.6 | 49.1 | 51.5 | 54.0 | 55.2 | 56.4 | 57.7 | 58.9 | 60.1 | 61.4 | 62.6 | 63.8 | 66.2 |
| 23 | 42.3 | 44.6 | 47.0 | 49.3 | 51.6 | 52.8 | 54.0 | 55.2 | 56.3 | 57.5 | 58.7 | 59.9 | 61.0 | 63.4 |
| 24 | 40.5 | 42.7 | 45.0 | 47.2 | 49.5 | 50.7 | 51.7 | 52.9 | 54.0 | 55.1 | 56.2 | 57.3 | 58.5 | 60.7 |
| 25 | 38.9 | 41.1 | 43.2 | 45.4 | 47.5 | 48.6 | 49.7 | 50.8 | 51.8 | 52.9 | 54.0 | 55.1 | 56.2 | 58.3 |
| 26 | 37.4 | 39.5 | 41.5 | 43.6 | 45.7 | 46.7 | 47.8 | 48.8 | 49.8 | 50.9 | 51.9 | 53.7 | 54.0 | 56.1 |

GEAR RATIOS NOT SHOWN ABOVE MAY BE CALCULATED AS FOLLOWS

$$\text{GEAR} = \frac{\text{Number of teeth on C/ring}}{\text{Number of teeth on Sprocket}} \times \text{Diameter of rear wheel in inches}$$